

### FEATURES

- **BROADBAND PERFORMANCE:** 10 to 1100 MHz
- **INPUT AND OUTPUT MATCHED TO 50  $\Omega$**
- **AVAILABLE IN CHIP OR HERMETIC PACKAGE**
- **EXCELLENT LINEARITY**  
Over +10 dBm Saturated Output Power
- **CASCADABLE FOR MULTISTAGE APPLICATIONS**
- **HIGH RELIABILITY**

### DESCRIPTION

The UPC1654A Silicon Microwave Monolithic IC is designed for general purpose and IF amplifier applications. This amplifier is matched to 50  $\Omega$  and is cascadable for multi-stage applications. The UPC1654A features excellent linearity with 10 dBm saturated output power and broadband performance up to 1100 MHz. Reliability and performance uniformity are assured by NEC's stringent quality control procedures. The UPC1654A is available in a hermetically sealed package.

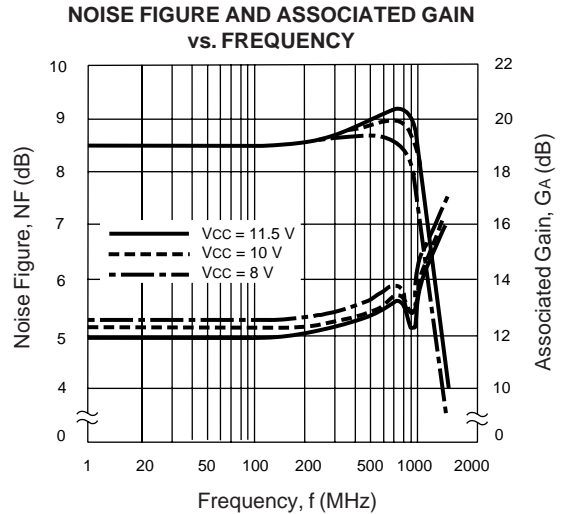

### ELECTRICAL CHARACTERISTICS (TA = 25°C, Vcc = 10 V, f = 500 MHz)

PART NUMBER PACKAGE OUTLINE			UPC1654A 15		
SYMBOLS	PARAMETERS AND CONDITIONS	UNITS	MIN	TYP	MAX
Icc	Operating Current	mA	38	43	48
Gs	Small Signal Gain	dB	17	19	21
BW	Bandwidth (The gain is 3 dB down from the gain at 100 MHz.)	MHz	950	1100	
PSAT	Saturated Output Power	dBm	9	10	
NF	Noise Figure	dB		5.5	6.5
RLIN	Input Return Loss	dB	15	18	
RLOUT	Output Return Loss	dB	9	12	
ISOL	Isolation	dB	24	27	
RTH (J-C)	Thermal Resistance (Junction to Case)	°C/W			30

**ABSOLUTE MAXIMUM RATINGS** (TA = 25°C)

SYMBOLS	PARAMETERS	UNITS	RATINGS
VCC	Supply Voltage	V	12
PT	Total Power Dissipation <sup>2</sup>	mW	750
PIN	Input Power	dBm	+10
TOP	Operating Temperature	°C	-55 to +125
TSTG	Storage Temperature	°C	-65 to +200

Note:

1. Operation in excess of any one of these parameters may result in permanent damage.
2. At TA = +125°C.

**EQUIVALENT CIRCUIT**

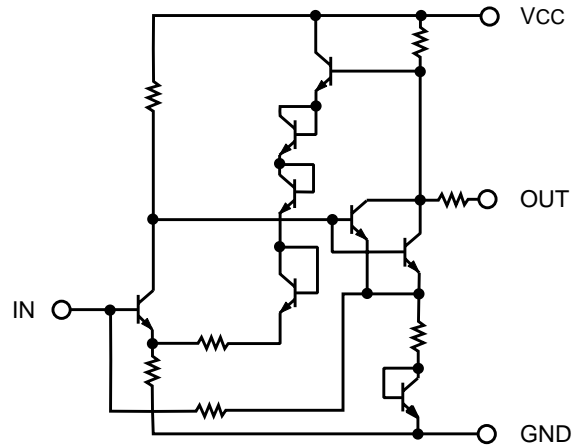

**TYPICAL PERFORMANCE CURVES** (TA = 25°C)

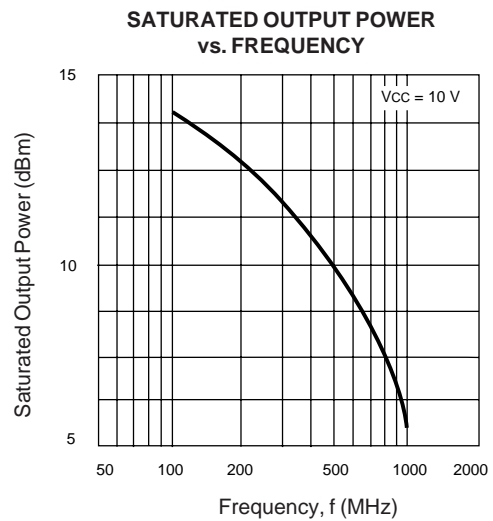
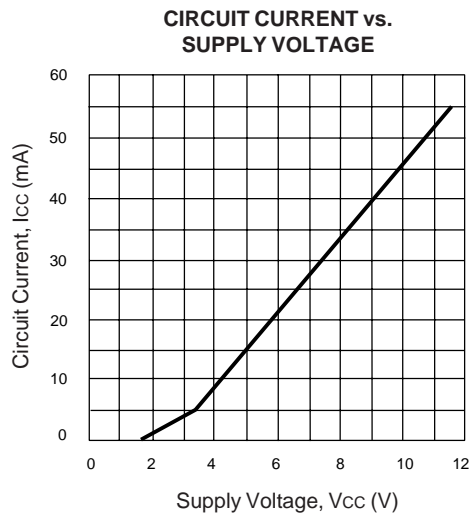
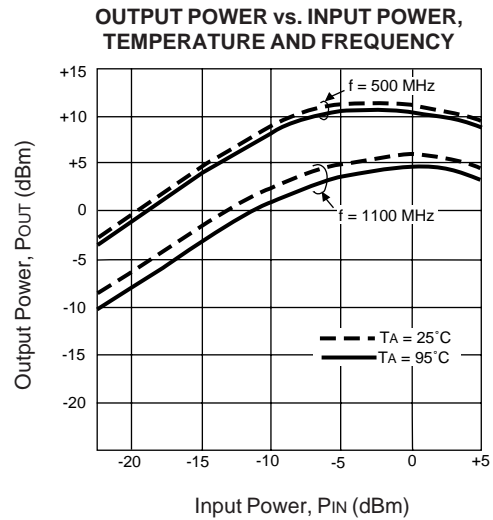
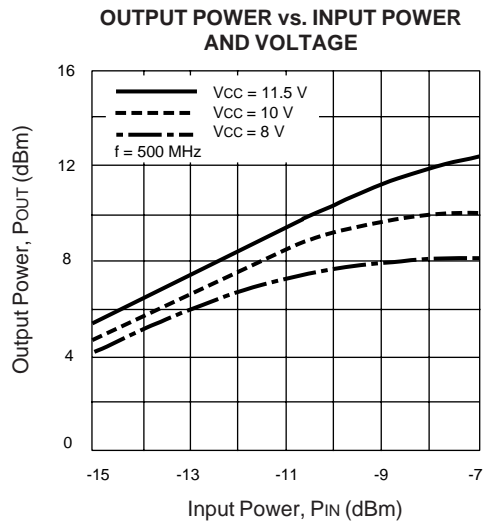

**TYPICAL PERFORMANCE CURVES** ( $T_A = 25^\circ\text{C}$ )

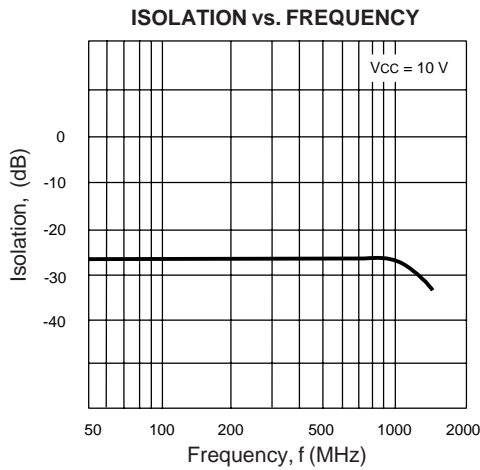
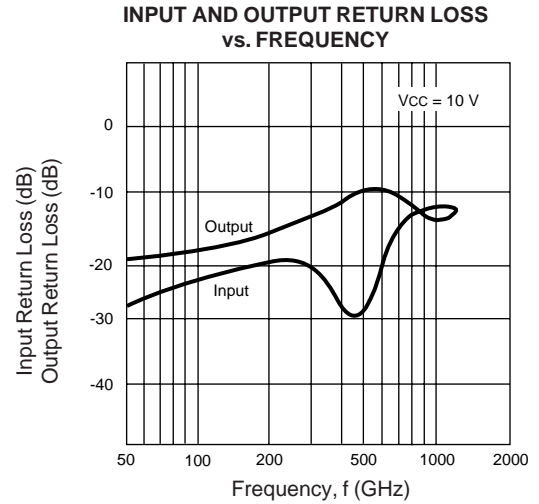
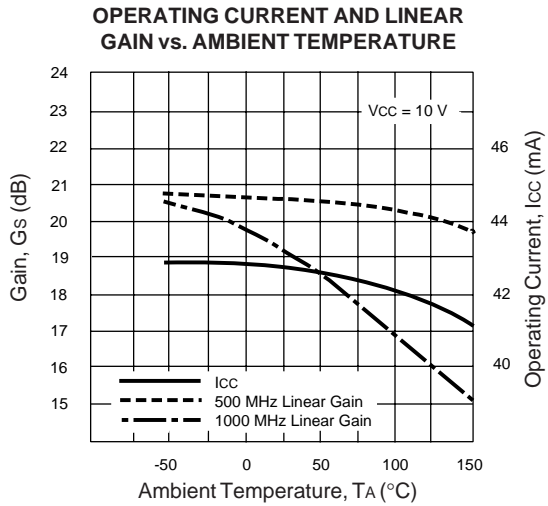

**OUTLINE DIMENSIONS** (Units in mm)

**UPC1654A**  
**PACKAGE OUTLINE 15**  
 (TO-33)

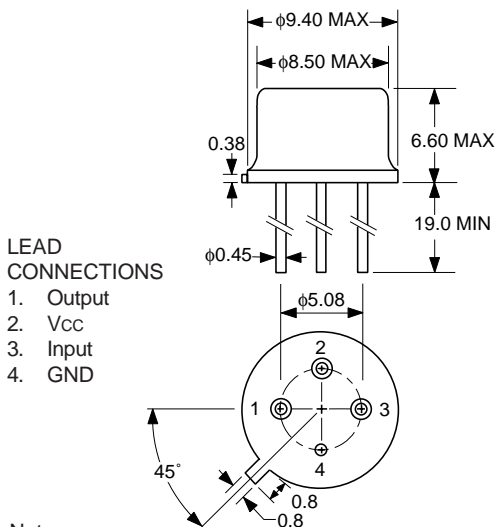

EXCLUSIVE AGENT FOR **NEC Corporation** RF & MICROWAVE SEMICONDUCTOR PRODUCTS - U.S. & CANADA

This datasheet has been downloaded from:

[www.DatasheetCatalog.com](http://www.DatasheetCatalog.com)

Datasheets for electronic components.