

Hyperabrupt Varactor-Tuned Oscillators

Technical Data

Features

- **25 MHz to 2.3 GHz Coverage**
- **Fast Tuning**
- **Fast Setting Time**
- **+20 VDC Max Tuning Voltage**
- **10 mW Output Power**
- **± 2.0 dB Output Flatness**
- **Hermetic Thin-film Construction**

Description

HP VTO-9000 Hyperabrupt Series oscillators use a silicon transistor chip as a negative resistance oscillator. The oscillation frequency is determined by a silicon hyperabrupt varactor diode acting as a voltage-variable capacitor in a thin-film microstripline resonator.

This provides extremely fast tuning speed limited primarily by the internal impedance of the user-supplied voltage driver.

This family of oscillators is similar to the standard commercial VTO-8000 Series except for the incorporation of a silicon hyperabrupt varactor tuning diode. This enables the oscillator to be tuned over the specified range in less than 20 volts rather than 40 to 50 volts in conventional oscillators.

The VTO-9000 Series VTOs are packaged in TO-8 transistor cans for simple installation in a conventional 50-ohm microstripline PC board. They are ideal for most compact

VTO-9000 Series

Pin Configuration TO-8V

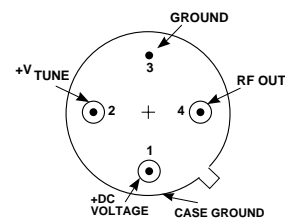

lightweight commercial and military equipment designs. Test fixturing is also available for lab bench test applications. See the "Test Fixtures for TO-8 Packages" section for additional information and outlines.

Applications

The VTO-9000 Series oscillators may be used in the same applications as VTO-8000 Series oscillators. The VTO-9000 Series is the desired choice for superior linearity and modulation sensitivity requirements.

Schematic

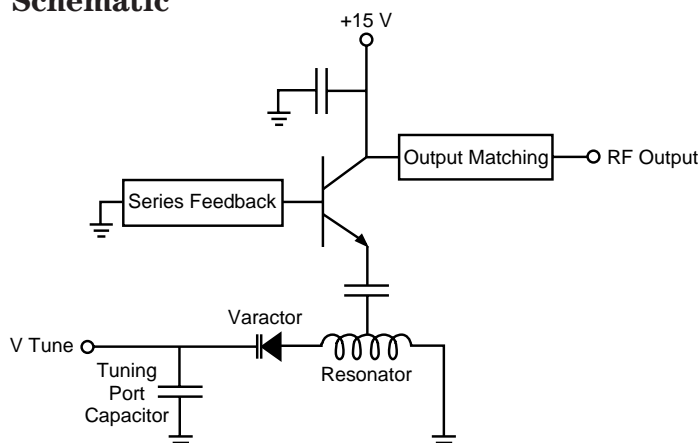

Electrical and Performance Specifications

Guaranteed Specifications @ 25°C Case Temperature (0° to +65°C Operating Temperature)

| Model No. | VTO-9032 | VTO-9050 | VTO-9068 | VTO-9090 |
|--|---------------|---------------|---------------|---------------|
| Frequency Range, Min. | 320–640 MHz | 500–1000 MHz | 680–1360 MHz, | 900–1600 MHz |
| Power Output Into 50–ohm Load, Min. | 10 mW/+10 dBm | 10 mW/+10 dBm | 10 mW/+10 dBm | 10 mW/+10 dBm |
| Power Output Variation @ 25°C, Max. | ± 2 dB | ± 2 dB | ± 2 dB | ± 2 dB |
| Operating Carrier Temperature Range | 0° to +65°C | 0° to +65°C | 0° to +65°C | 0° to +65°C |
| Frequency Drift Over Operating Temperature, Typ. | 12 MHz | 20 MHz | 20 MHz | 20 MHz |
| Pulling Figure (12 dB Return Loss), Typ. | 20 MHz | 20 MHz | 25 MHz | 25 MHz |
| Pushing Figure, +15 VDC Supply, Typ. | 5 MHz/V | 5 MHz/V | 6 MHz/V | 6 MHz/V |
| Harmonics, Below Carrier, Typ. | -14 dB | -10 dB | -14 dB | -14 dB |
| Spurious Output Below Carrier, Min. | -60 dB | -60 dB | -60 dB | -60 dB |
| Tuning Voltage | | | | |
| Low Frequency, Min. | 0 VDC | 0 VDC | 0 VDC | 2 VDC |
| High Frequency, Max | 20 VDC | 20 VDC | 20 VDC | 18 VDC |
| Maximum Tuning Voltage | +20 VDC | +20 VDC | +20 VDC | +20 VDC |
| Tuning Port Capacitance, Nom. | 200 pF | 200 pF | 190 pF | 190 pF |
| Phase Noise, Single Sideband, | | | | |
| 1 Hz Bandwidth, Typ. | | | | |
| 50 kHz From Carrier | -95 dBc/Hz | -100 dBc/Hz | -95 dBc/Hz | -100 dBc/Hz |
| 100 kHz From Carrier | -103 dBc/Hz | -108 dBc/Hz | -103 dBc/Hz | -108 dBc/Hz |
| Input Power, ± 1% Regulation | | | | |
| Voltage, Nom. | +15 VDC | +15 VDC | +15 VDC | +15 VDC |
| Current, Max. | 50 mA | 50 mA | 50 mA | 50 mA |
| Case Style | TO-8V | TO-8V | TO-8V | TO-8V |

Electrical and Performance Specifications

Guaranteed Specifications @ 25°C Case Temperature (0° to +65°C Operating Temperature)

| Model No. | VTO-9120 | VTO-9130 |
|--|---------------|---------------|
| Frequency Range, Min. | 1200–2000 MHz | 1300–2300 MHz |
| Power Output Into 50–ohm load, Min. | 10 mW/+10 dBm | 10 mW/+10 dBm |
| Power Output Variation @ 25°C, Max. | ± 2 dB | ± 1.5 dB |
| Operating Case Temperature Range | 0° to +65°C | 0° to +65°C |
| Frequency Drift Over Operating Temperature, Typ. | 25 MHz | 25 MHz |
| Pulling Figure (12 dB Return Loss), Typ. | 25 MHz | 50 MHz |
| Pushing Figure, +15 VDC Supply, Typ. | 10 MHz/V | 10 MHz/V |
| Harmonics, Below Carrier, Typ. | -14 dB | -15 dB |
| Spurious Output Below Carrier, Min. | -60 dB | -60 dB |
| Tuning Voltage | | |
| Low Frequency | 3± 1 VDC | 2 VDC Min. |
| High Frequency | 12± 2 VDC | 20 VDC Max. |
| Maximum Tuning Voltage | +20 VDC | + 20 VDC |
| Tuning Port Capacitance, Nom. | 100 pF | 100 pF |
| Phase Noise, Single Sideband, | | |
| 1 Hz, Bandwidth, Typ. | | |
| 50 kHz From Carrier | -97 dBc/Hz | -97 dBc/Hz |
| 100 kHz From Carrier | -105 dBc/Hz | -105 dBc/Hz |
| Input Power, ± 1% Regulation | | |
| Voltage, Nom. | +15 VDC | +15 VDC |
| Current, Max. | 50 mA | 50 mA |
| Case Style | TO-8V | TO-8V |

Typical Performance @ 25°C Case Temperature

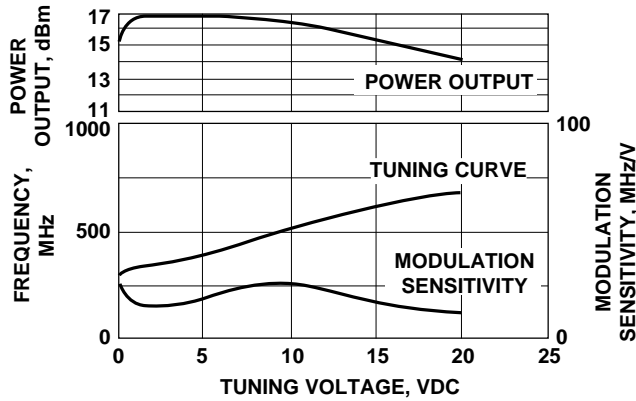

Figure 1. VTO-9032 Power Output, Frequency and Modulation Sensitivity vs. Tuning Voltage

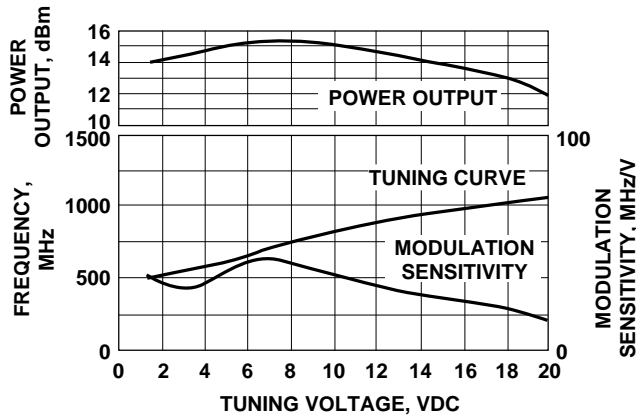

Figure 3. VTO-9050 Power Output, Frequency and Modulation Sensitivity vs. Tuning Voltage.

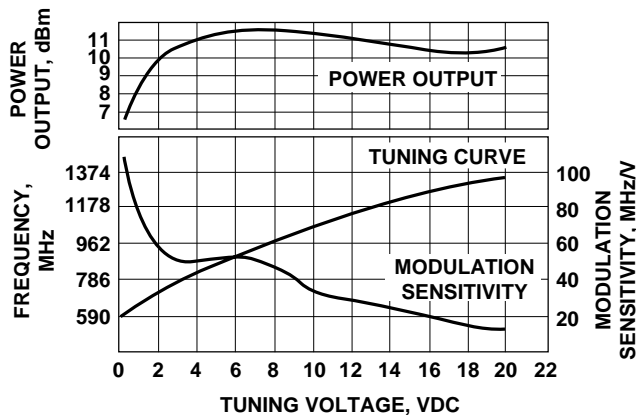

Figure 5. VTO-9068 Power Output, Frequency and Modulation Sensitivity vs. Tuning Voltage.

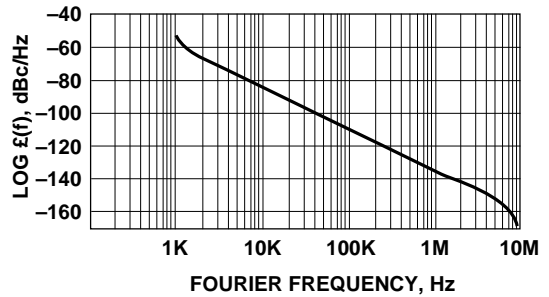

Figure 2. VTO-9032 Normalized Phase Noise @ 640 MHz S.S.B. Power Spectral Density.

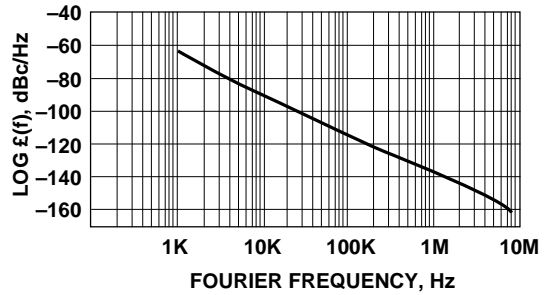

Figure 4. VTO-9050 Normalized Phase Noise @ 1000 MHz S.S.B. Power Spectral Density.

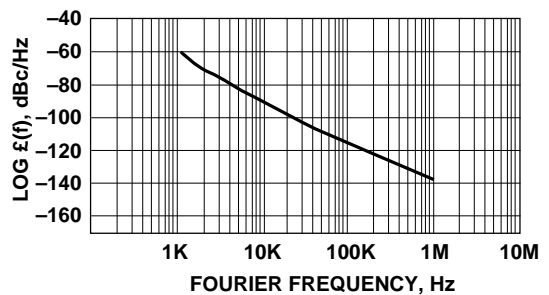

Figure 6. VTO-9068 Normalized Phase Noise @ 1360 MHz S.S.B. Power Spectral Density.

Typical Performance @ 25°C Case Temperature (continued)

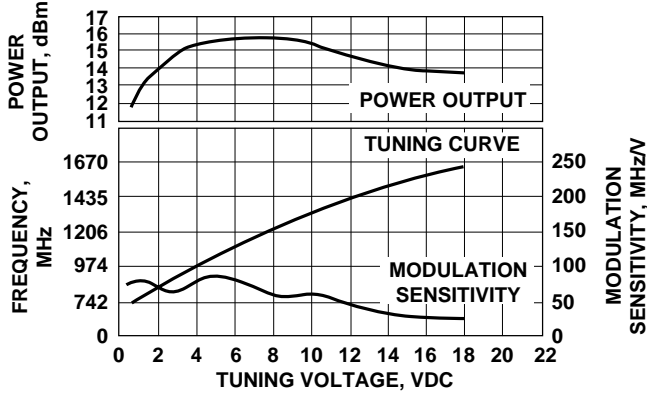

Figure 7. VTO-9090 Power Output, Frequency and Modulation Sensitivity vs. Tuning Voltage.

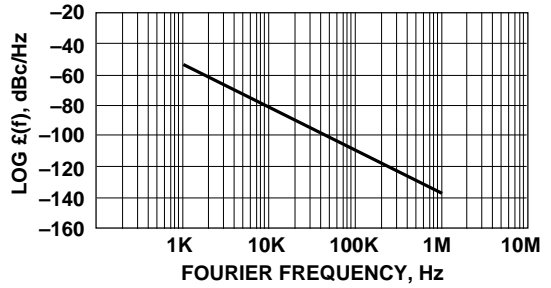

Figure 8. VTO-9090 Noise @ 1000 MHz Single Sideband Phase Noise.

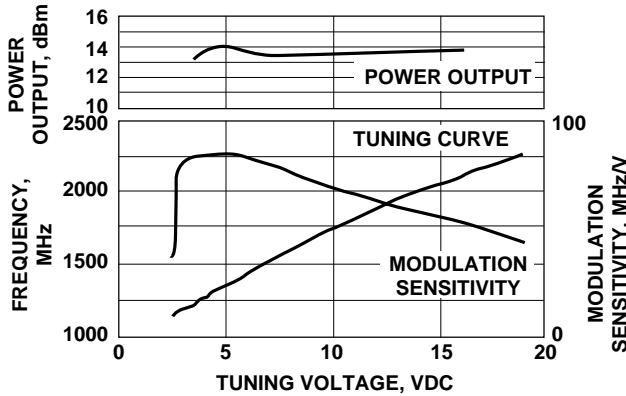

Figure 9. VTO-9120 Power Output, Frequency and Modulation Sensitivity vs. Tuning Voltage.

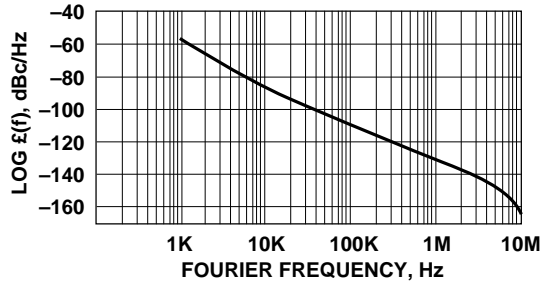

Figure 10. VTO-9120 Normalized Phase Noise @ 2000 MHz S.S.B. Power Spectral Density.

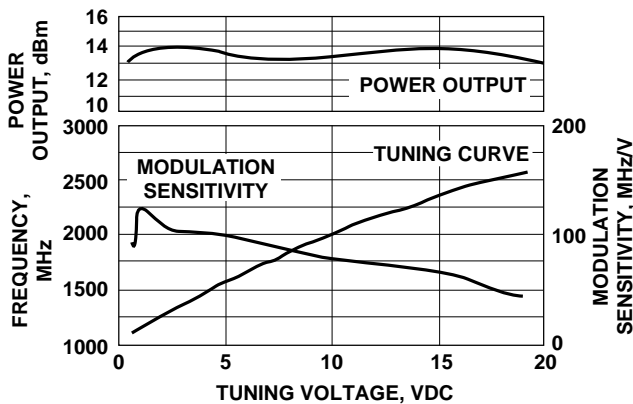

Figure 11. VTO-9130 Power Output, Frequency and Modulation Sensitivity vs. Tuning Voltage.

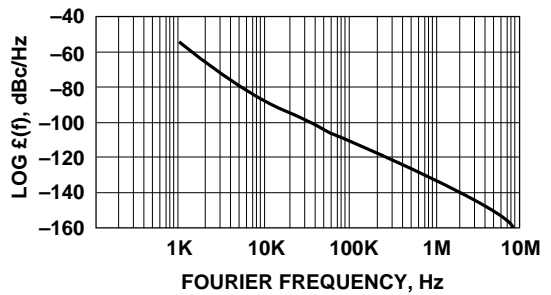
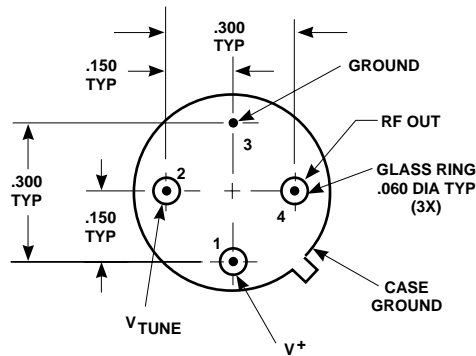
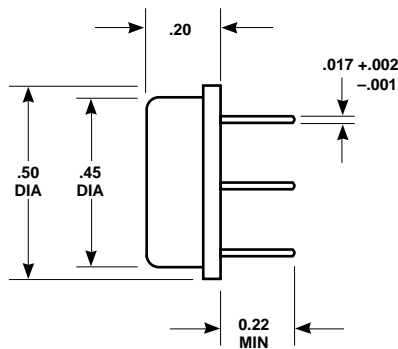

Figure 12. VTO-9130 Normalized Phase Noise @ 2300 MHz S.S.B. Power Spectral Density.

TO-8V Case Drawing



APPROXIMATE WEIGHT 1.7 GRAMS

NOTES (UNLESS OTHERWISE SPECIFIED):
 1. DIMENSIONS ARE SPECIFIED IN INCHES
 2. TOLERANCES: xx ± .02
 xxx ± .010

Test Fixtures for TO-8 Packages (TF 801/802) Oscillators (VTO)

Features

- DC to 11 GHz Frequency Range
- Connectorized Tuning Port and RF Output
- Easy to Test Package
- Repeatable Performance

Applications

- Engineering Characterization
- Incoming Inspection
- System Prototype
- Demonstration of Device Performance

Description

To facilitate testing and prototyping of products in the TO-8V package, a series of test fixtures is available. Designated the HP TF Series test fixtures, they feature rugged construction for precise, repeatable measurements.

The TF Series test fixtures come supplied with mounting hardware to ensure excellent ground contact between the oscillator package and test fixture. This assures excellent contact between package pins and test fixture connector pins for reliable testing.

The device under test is aligned according to Figure 13, and pushed fully down onto the fixture. The steel mounting ring

clamp is placed over the device under test and secured by machine screws prior to testing. Orientation of pins can be verified by comparison with part (c) of Figure 13. It is recommended that both machine screws be used to fasten the ring clamp. Screws should be tightened down snugly with a jewelers type screwdriver.

For different connector options check the table in Figure 13 to identify the correct part numbers.

It should be noted that some output power variation may be seen, from unit data, at frequencies above 8 GHz. This is due to small differences in lengths of test fixture RF output connector pins.

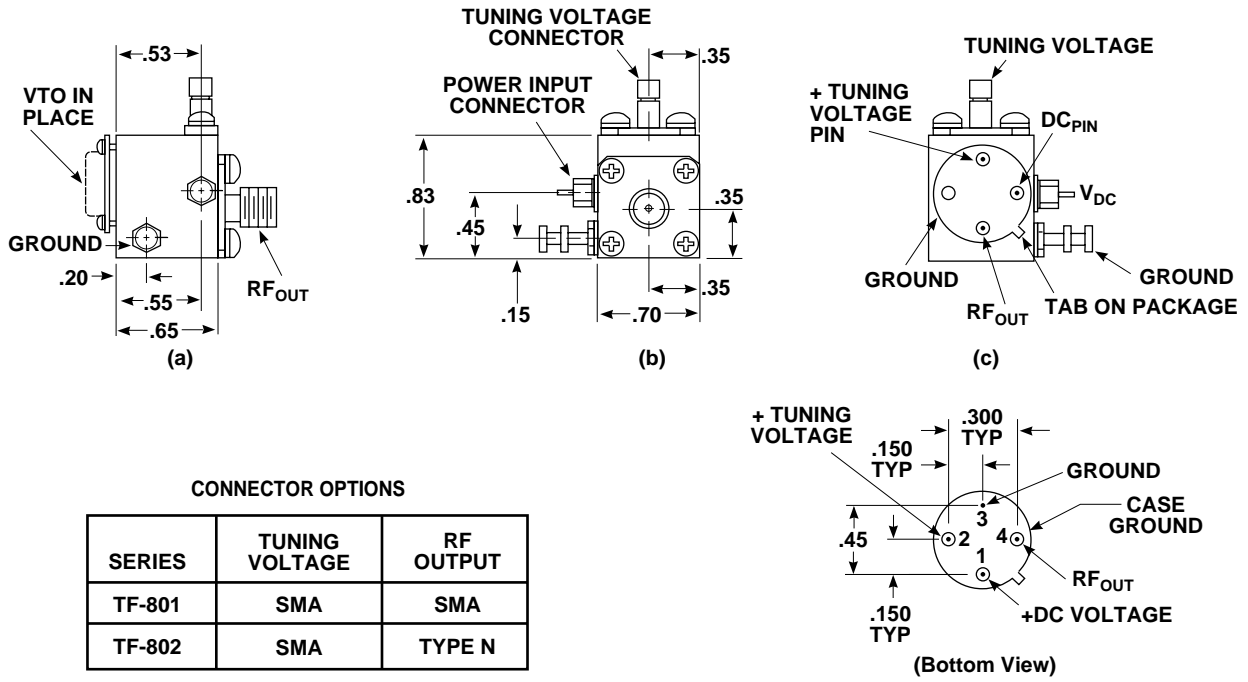

Figure 13. TO-8 Test Fixture.