

CMOS TIMER

Description

The μ PD5555 is a CMOS RC timer providing significantly improved performance over the standard bipolar 555 timer, while at the same time being direct replacement for that device in most applications. Improved parameters include low supply current, wide operating supply voltage range, THRESHOLD, TRIGGER and RESET currents as low as 2 pA, no crowbarring of the power supply during output transitions, higher frequency performance, and no requirement to decouple control voltage for stable operation.

Specifically, the μ PD5555 is stable controller capable of producing accurate time delays or frequencies.

In the one-shot mode, the pulse width of each circuit is precisely controlled by one external resistor and capacitor. For astable operation as an oscillator, the free running frequency and the duty cycle are controlled by two external resistors and one capacitor. The circuits can source or sink current large enough to drive TTL loads or provide minimal offsets to drive CMOS loads.

Features

- Exact equivalent in most cases for industry standard 555 timer
- Low supply current
- 3 to 16 V operating voltage range
- Timing from microseconds through hours

CONNECTION DIAGRAM (Top View)

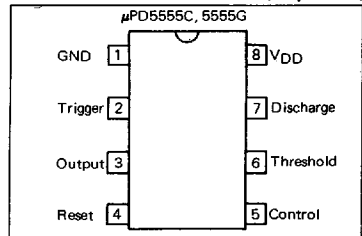

EQUIVALENT CIRCUIT

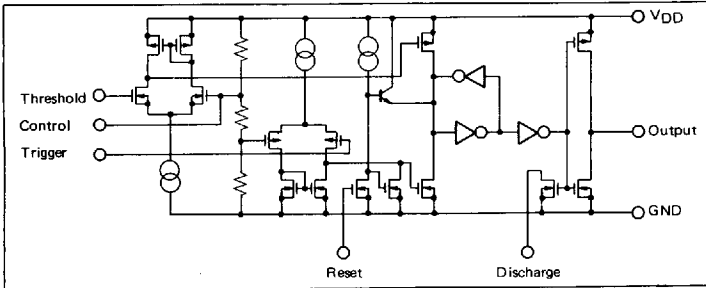

ORDERING INFORMATION

Part Number	Package
μ PD5555C	8 PIN PLASTIC DIP (300 mil)
μ PD5555G2	8 PIN PLASTIC SOP (225 mil)

NEC cannot assume any responsibility for any circuits shown or represent that they are free from patent infringement.

© NEC Corporation 1987

■ 6427525 0070547 180 ■

ABSOLUTE MAXIMUM RATINGS ($T_a=25^\circ\text{C}$)

PARAMETER		SYMBOL	μ PD5555	UNIT
Supply Voltage		V_{DD}	18	V
Input Voltage (Trigger, Threshold, Reset, Control)		V_{IN}	$GND - 0.3 \leq V_{IN} \leq V_{DD} + 0.3$	V
Output Current		I_O	100	mA
Operating Temperature Range		T_{opt}	$-20 \sim +70$	$^\circ\text{C}$
Storage Temperature Range		T_{stg}	$-55 \sim +125$	$^\circ\text{C}$
Power Dissipation	C Package (Note 1)	P_T	350	mW
	G Package (Note 2)		440	

Note 1: Thermal derating factor is $-5 \text{ mW}/^\circ\text{C}$ when ambient temperature is higher than 55°C .

Note 2: Thermal derating factor is $-4.4 \text{ mW}/^\circ\text{C}$ when ambient temperature is higher than 25°C .

RECOMMENDED OPERATING CONDITIONS

CHARACTERISTIC	SYMBOL	MIN.	TYP.	MAX.	UNIT
Oscillation Frequency				500	kHz
Supply Voltage	V_{DD}	3		16	V
Input Voltage	V_{IN}	0		V_{DD}	V
Output Sink Current	$I_O \text{ SINK}$			3.2	mA
Output Source Current	$I_O \text{ SOURCE}$			1	mA
Operating Temperature	T_{opt}	-20		70	$^\circ\text{C}$

ELECTRICAL CHARACTERISTICS (T_a=25 °C, V_{DD}=+3~+15 V)

CHARACTERISTIC	SYMBOL	MIN.	TYP.	MAX.	UNIT	CONDITION
Supply Current	I _{DD}		115	250	μA	V _{DD} =5 V
			150	350		V _{DD} =15 V
Threshold Voltage	V _{th}		2/3 V _{DD}		V	
Threshold Current	I _{th}		50		pA	V _{DD} =15 V
			10			V _{DD} =5 V
			1			V _{DD} =3 V
Trigger Voltage	V _{tr}		1/3 V _{DD}		V	
Trigger Current	I _{tr}		50		pA	V _{DD} =15 V
			10			V _{DD} =5 V
			1			V _{DD} =3 V
Reset Voltage (V _O becomes low)	V _{reset}	0.6	1.1	2.0	V	V _{DD} =15 V
		0.6	1.1	2.0		V _{DD} =3 V
Reset Current	I _{reset}		100		pA	V _{RESET} =GND, V _{DD} =15 V
			20			V _{RESET} =GND, V _{DD} =5 V
			2			V _{RESET} =GND, V _{DD} =3 V
Output Low Voltage	V _{OL}		0.06	0.4	V	V _{DD} =15 V, I _{SINK} =3.2 mA
			0.14	0.4		V _{DD} =5 V, I _{SINK} =3.2 mA
Output High Voltage	V _{OH}	14.25	14.85		V	V _{DD} =15 V, I _{SOURCE} =1 mA
		4.0	4.7			V _{DD} =5 V, I _{SOURCE} =1 mA
Output Rise Time	t _{rise}		40		ns	R _L =10 MΩ, C _L =7 pF, V _{DD} =5 V
Output Fall Time	t _{fall}		40		ns	R _L =10 MΩ, C _L =7 pF, V _{DD} =5 V
Max. Oscillation Frequency		500			kHz	Astable Operation
Propagation Delay	t _{pd}		350		ns	Monostable Operation Trigger Level = 0.1 · V _{DD}
Minimum Trigger Pulse Width (V _{DD} =5 V)	t _{tr}		160		ns	Trigger Level = 0.1 · V _{DD}
Control Voltage	V _{cont}		2/3 V _{DD}		V	
Timing Error Initial Accuracy			2		%	R ₁ , R ₂ =1 k~100 kΩ C=0.1 μF V _{DD} =5~15 V
Temperature Drift			50		ppm/°C	
Supply Voltage Drift			1		%/V	

Note 1: To reduce transient switching noise on the supply voltage line, install a bypass capacitor from V_{DD} to ground. Connect the capacitor, with value listed below, close to V_{DD}.

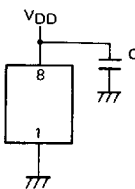

Capacitance C ≥ 0.047 μF V_{DD} ≤ 10 V
 C ≥ 0.1 μF V_{DD} > 10 V

Note 2: Install a series resistor (R ≥ 4.7 kΩ) to Reset, when reset is controlled by digital devices.

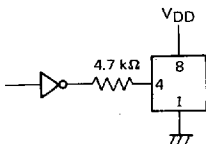

6427525 0070549 T53

TYPICAL PERFORMANCE CHARACTERISTICS ($T_a=25^\circ\text{C}$)

SUPPLY CURRENT

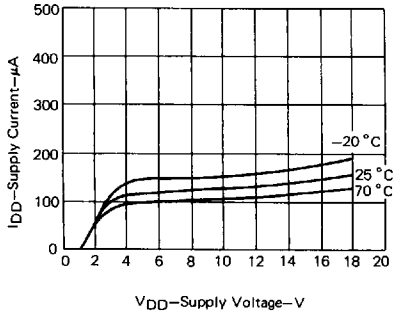

OUTPUT SINK CURRENT

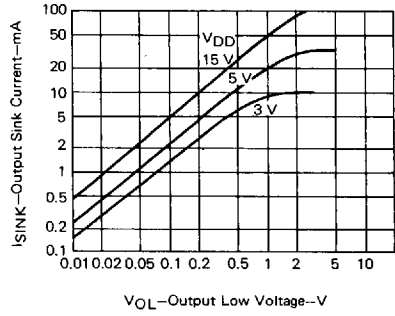

OUTPUT SOURCE CURRENT

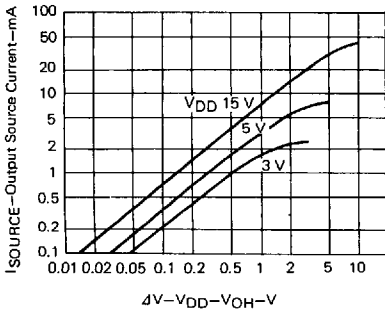

DISCHARGE CURRENT

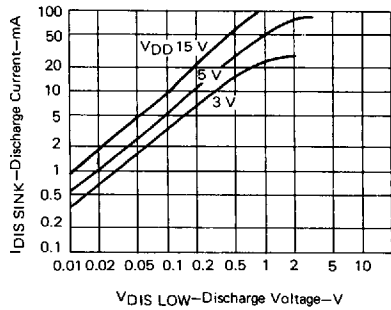

OUTPUT LOW VOLTAGE

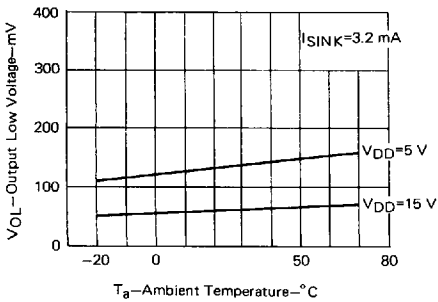

V_{DD} -OUTPUT HIGH VOLTAGE

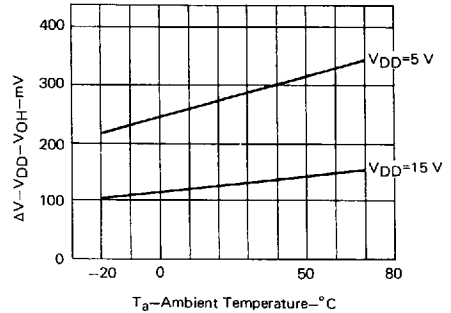

DISCHARGE VOLTAGE

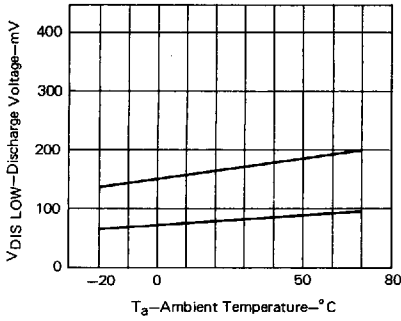

DYNAMIC CURRENT

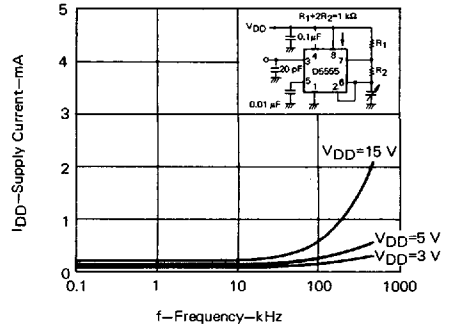

PROPAGATION DELAY

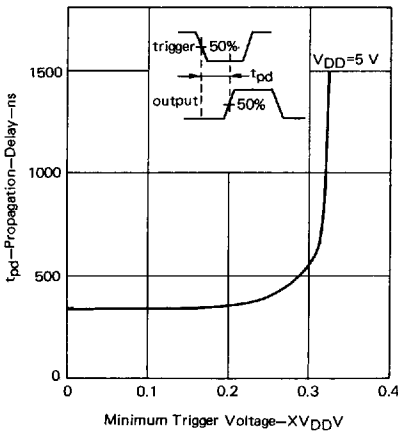

MINIMUM TRIGGER PULSE WIDTH

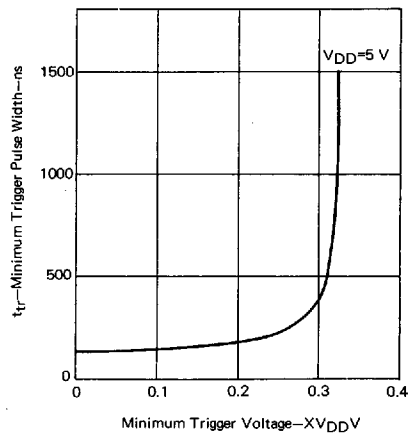

PROPAGATION DELAY

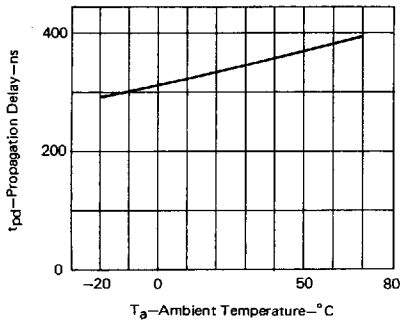

MINIMUM TRIGGER PULSE WIDTH

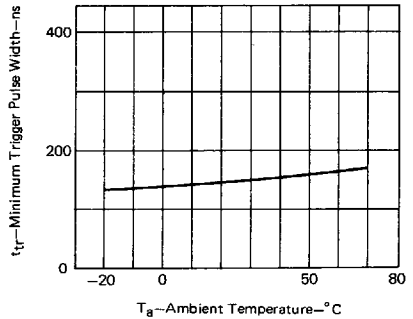

FREE RUNNING FREQUENCY

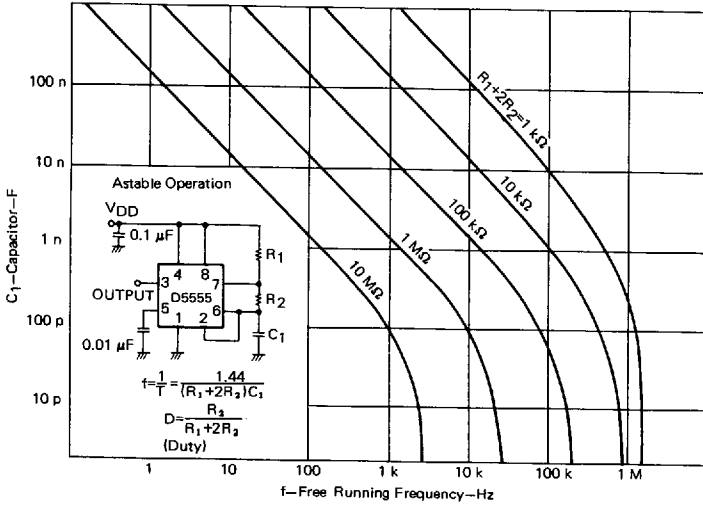

TIME DELAY

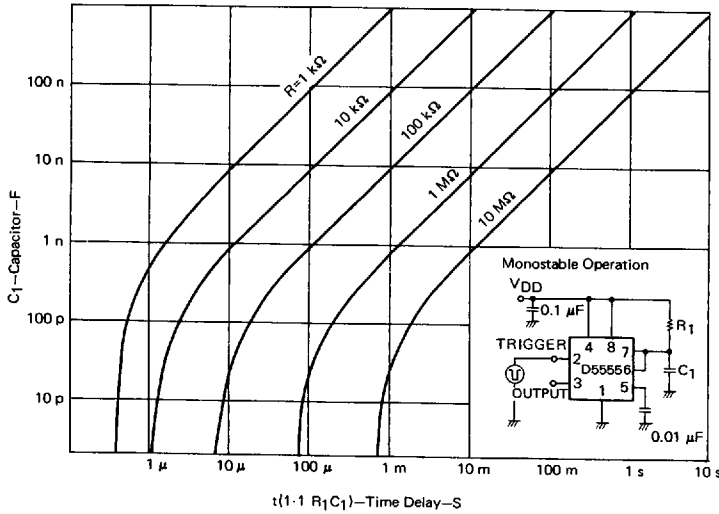

8PIN PLASTIC DIP (300 mil)

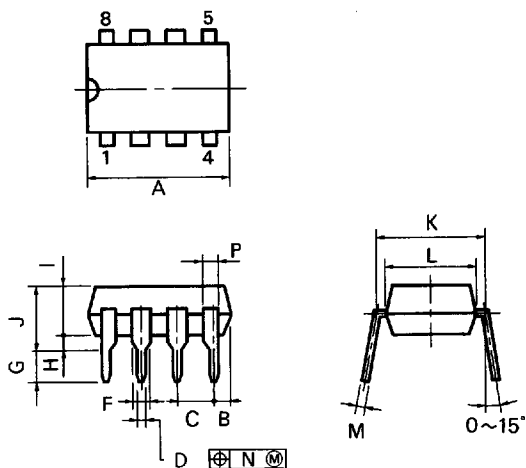

P8C-100-300B,C

NOTES

- 1) Each lead centerline is located within 0.25 mm (0.01 inch) of its true position (T.P.) at maximum material condition.
- 2) Item "K" to center of leads when formed parallel.

ITEM	MILLIMETERS	INCHES
A	10.16 MAX.	0.400 MAX.
B	1.27 MAX.	0.050 MAX.
C	2.54 (T.P.)	0.100 (T.P.)
D	0.50 ^{+0.10}	0.020 ^{+0.004}
F	1.4 MIN.	0.055 MIN.
G	3.2 ^{+0.3}	0.126 ^{+0.012}
H	0.51 MIN.	0.020 MIN.
I	4.31 MAX.	0.170 MAX.
J	5.08 MAX.	0.200 MAX.
K	7.62 (T.P.)	0.300 (T.P.)
L	6.4	0.252
M	0.25 ^{+0.10}	0.010 ^{+0.004}
N	0.25	0.01
P	0.9 MIN.	0.035 MIN.

■ 6427525 0070553 484 ■

8PIN PLASTIC SOP (225 mil)

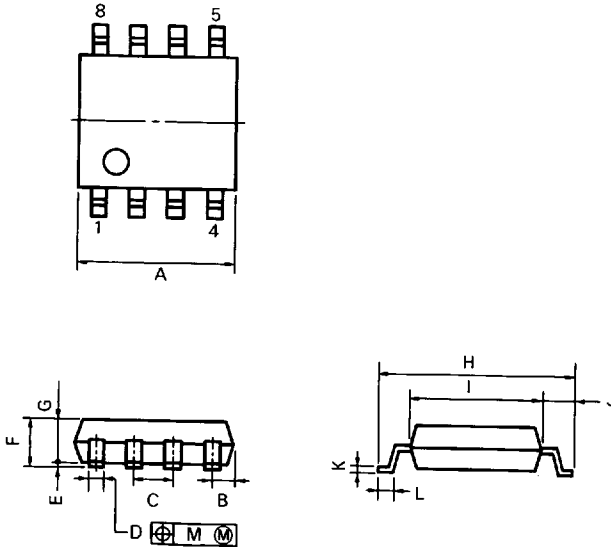

S8GM-50-225B

NOTE

Each lead centerline is located within 0.12 mm (0.005 inch) of its true position (T.P.) at maximum material condition.

ITEM	MILLIMETERS	INCHES
A	5.70 MAX.	0.225 MAX.
B	0.94 MAX.	0.037 MAX.
C	1.27 (T.P.)	0.050 (T.P.)
D	0.40 ^{+0.10} _{-0.08}	0.016 ^{+0.004} _{-0.003}
E	0.1 ^{+0.1}	0.004 ^{+0.004}
F	1.8 MAX.	0.071 MAX.
G	1.49	0.059
H	6.5 ^{+0.3}	0.256 ^{+0.012}
I	4.4	0.173
J	1.1	0.043
K	0.15 ^{+0.10} _{-0.08}	0.006 ^{+0.004} _{-0.003}
L	0.6 ^{+0.2}	0.024 ^{+0.008} _{-0.008}
M	0.12	0.005