

THREE TERMINAL POSITIVE VOLTAGE REGULATORS
5V, *6V, *8V, 9V, 10V, 12V, 15V, *18V, *20V, 24V

* Under development

- . Suitable for C-MOS, TTL, the other Digital IC's Power Supply
- . Internal Thermal Overload Protection
- . Internal Short Circuit Current Limiting
- . Output Current in excess of 1A

Unit in mm

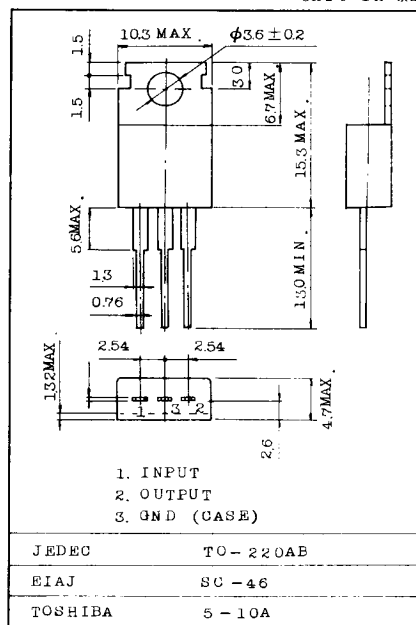

MOUNTING KIT NO. AC75.

MAXIMUM RATINGS (Ta=25°C)

CHARACTERISTIC	SYMBOL	RATING	UNIT
Input Voltage	V _{IN}	35	V
		40	
Power Dissipation (Note)	P _D	20.8	W
Operating Temperature	T _{opr}	-30 ~ 75	°C
Storage Temperature	T _{stg}	-55 ~ 150	°C

Note : Tc=25°C

TA78005AP ~ TA78024AP

EQUIVALENT CIRCUIT

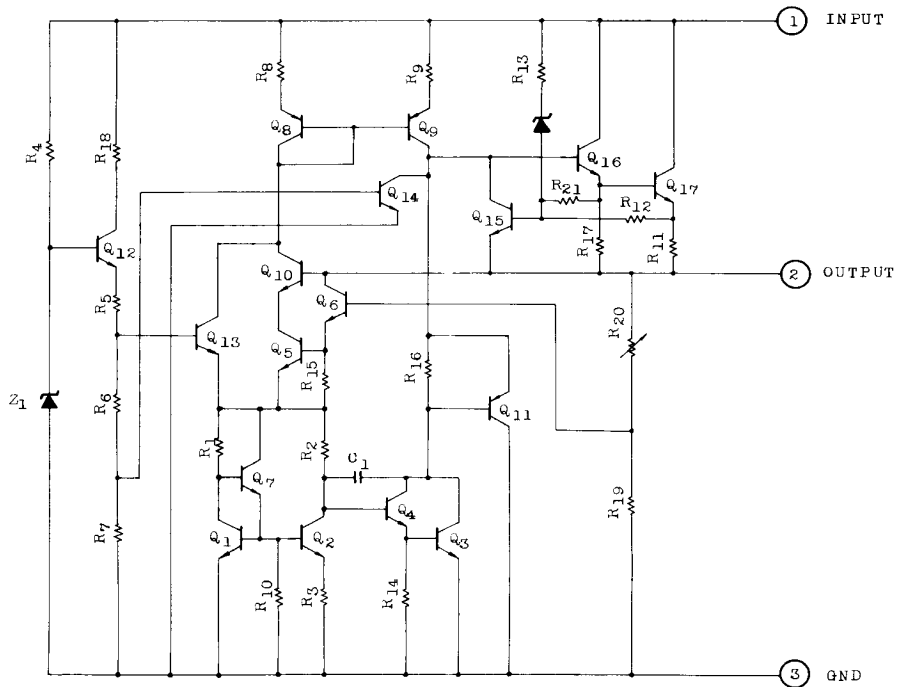

ELECTRICAL CHARACTERISTICS ($V_{IN}=10V$, $I_{OUT}=500mA$, $0^{\circ}C \leq T_j \leq 125^{\circ}C$)

CHARACTERISTIC	SYMBOL	TEST CIR-CUIT	TEST CONDITION	MIN.	TYP.	MAX.	UNIT	
Output Voltage	V_{OUT}	1	$T_j=25^{\circ}C$, $I_{OUT}=100mA$	4.8	5.0	5.2	V	
Input Regulation	Reg.line	1	$T_j=25^{\circ}C$	$7.0V \leq V_{IN} \leq 2.5V$	-	3	100	mV
				$8.0V \leq V_{IN} \leq 12V$	-	1	50	
Load Regulation	Reg.load	1	$T_j=25^{\circ}C$	$5mA \leq I_{OUT} \leq 1.4A$	-	15	100	mV
				$250mA \leq I_{OUT} \leq 750mA$	-	5	50	
Output Voltage	V_{OUT}	1	$7.0V \leq V_{IN} \leq 20V$ $5.0mA \leq I_{OUT} \leq 1.0A, P_o \leq 15W$	4.75	-	5.25	V	
Quiescent Current	I_B	1	$T_j=25^{\circ}C$, $I_{OUT}=5mA$	-	4.2	8.0	mA	
Quiescent Current Change	ΔI_B	1	$7.0V \leq V_{IN} \leq 25V$	-	-	1.3	mA	
Output Noise Voltage	V_{NO}	1	$T_a=25^{\circ}C$, $10Hz \leq f \leq 100kHz$ $I_{OUT}=50mA$	-	50	-	μV	
Ripple Rejection	RR	1	$f=120Hz$, $8.0V \leq V_{IN} \leq 18V$ $I_{OUT}=50mA$, $T_j=25^{\circ}C$	62	78	-	dB	
Dropout Voltage	V_D	1	$I_{OUT}=1.0A$, $T_j=25^{\circ}C$	-	2.0	-	V	
Short Circuit Current Limit	I_{SC}	1	$T_j=25^{\circ}C$	-	1.6	-	A	
Average Temperature Coefficient of Output Voltage	$TCVO$	1	$I_{OUT}=5mA$, $0^{\circ}C \leq T_j \leq 125^{\circ}C$	-	-0.6	-	mV/deg	

TA78005AP ~ TA78024AP

ELECTRICAL CHARACTERISTICS ($V_{IN}=11V$, $I_{OUT}=500mA$, $0^{\circ}C \leq T_j \leq 125^{\circ}C$)

CHARACTERISTIC	SYMBOL	TEST CIR-CUIT	TEST CONDITION	MIN.	TYP.	MAX.	UNIT	
Output Voltage	V_{OUT}	1	$T_j=25^{\circ}C$, $I_{OUT}=100mA$	5.75	6.0	6.25	V	
Input Regulation	Reg.line	1	$T_j=25^{\circ}C$	$8.0V \leq V_{IN} \leq 25V$	-	4	120	mV
				$9V \leq V_{IN} \leq 13V$	-	2	60	
Load Regulation	Reg.load	1	$T_j=25^{\circ}C$	$5mA \leq I_{OUT} \leq 1.4A$	-	15	120	mV
				$250mA \leq I_{OUT} \leq 750mA$	-	5	60	
Output Voltage	V_{OUT}	1	$8V \leq V_{IN} \leq 21V$ $5.0mA \leq I_{OUT} \leq 1.0A$, $P_o \leq 15W$	5.7	-	6.3	V	
Quiescent Current	I_B	1	$T_j=25^{\circ}C$, $I_{OUT}=5mA$	-	4.3	8.0	mA	
Quiescent Current Change	ΔI_B	1	$8.0V \leq V_{IN} \leq 25V$	-	-	1.3	mA	
Output Noise Voltage	V_{NO}	1	$T_a=25^{\circ}C$, $10Hz \leq f \leq 100Hz$ $I_{OUT}=50mA$	-	55	-	μV	
Ripple Rejection	RR	1	$f=120Hz$, $9V \leq V_{IN} \leq 19V$ $I_{OUT}=50mA$, $T_j=25^{\circ}C$	61	77	-	dB	
Dropout Voltage	V_D	1	$I_{OUT}=1.0A$, $T_j=25^{\circ}C$	-	2.0	-	V	
Short Circuit Current Limit	I_{SC}	1	$T_j=25^{\circ}C$	-	1.5	-	A	
Average Temperature Coefficient of Output Voltage	T_{CVO}	1	$I_{OUT}=5mA$, $0^{\circ}C \leq T_j \leq 125^{\circ}C$	-	-0.7	-	mV/deg	

ELECTRICAL CHARACTERISTICS ($V_{IN}=14V$, $I_{OUT}=500mA$, $0^{\circ}C \leq T_j \leq 125^{\circ}C$)

CHARACTERISTIC	SYMBOL	TEST CIR-CUIT	TEST CONDITION	MIN.	TYP.	MAX.	UNIT
Output Voltage	V_{OUT}	1	$T_j=25^{\circ}C$, $I_{OUT}=100mA$	7.7	8.0	8.3	V
Input Regulation	Reg·line	1	$T_j=25^{\circ}C$ $10.5V \leq V_{IN} \leq 25V$	-	6	160	mV
			$11V \leq V_{IN} \leq 17V$	-	2	80	
Load Regulation	Reg·load	1	$T_j=25^{\circ}C$ $5mA \leq I_{OUT} \leq 1.4A$	-	12	160	mV
			$250mA \leq I_{OUT} \leq 50mA$	-	4	80	
Output Voltage	V_{OUT}	1	$10.5V \leq V_{IN} \leq 23V$ $5.0mA \leq I_{OUT} \leq 1.0A$, $P_o \leq 15W$	7.6	-	8.4	V
Quiescent Current	I_B	1	$T_j=25^{\circ}C$, $I_{OUT}=5mA$	-	4.3	8.0	mA
Quiescent Current Change	ΔI_B	1	$10.5V \leq V_{IN} \leq 25V$	-	-	1.0	mA
Output Noise Voltage	V_{NO}	1	$T_a=25^{\circ}C$, $10Hz \leq f \leq 100kHz$ $I_{OUT}=50mA$	-	70	-	μV
Ripple Rejection	RR	1	$f=120Hz$, $11.5V \leq V_{IN} \leq 21.5V$ $I_{OUT}=50mA$, $T_j=25^{\circ}C$	58	74	-	dB
Dropout Voltage	V_D	1	$I_{OUT}=1.0A$, $T_j=25^{\circ}C$	-	2.0	-	V
Short Circuit Current Limit	I_{SC}	1	$T_j=25^{\circ}C$	-	1.1	-	A
Average Temperature Coefficient of Output Voltage	T_{CVO}	1	$I_{OUT}=5mA$, $0^{\circ}C \leq T_j \leq 125^{\circ}C$	-	-1.0	-	mV/deg

TA78005AP ~ TA78024AP

ELECTRICAL CHARACTERISTICS ($V_{IN}=15V$, $I_{OUT}=500mA$, $0^{\circ}C \leq T_j \leq 125^{\circ}C$)

CHARACTERISTIC	SYMBOL	TEST CIR-CUIT	TEST CONDITION	MIN.	TYP.	MAX.	UNIT
Output Voltage	V_{OUT}	1	$T_j=25^{\circ}C$, $I_{OUT}=100mA$	8.64	9.0	9.36	V
Input Regulation	Reg.line	1	$T_j=25^{\circ}C$ $11.5V \leq V_{IN} \leq 26V$	-	7.0	180	mV
			$13V \leq V_{IN} \leq 19V$	-	2.5	90	
Load Regulation	Reg.load	1	$T_j=25^{\circ}C$ $5mA \leq I_{OUT} \leq 1.4A$	-	12	180	mV
			$250mA \leq I_{OUT} \leq 750mA$	-	4.0	90	
Output Voltage	V_{OUT}	1	$11.5V \leq V_{IN} \leq 2.6V$ $5.0mA \leq I_{OUT} \leq 1.0A, P_o \leq 15W$	8.55	-	9.45	V
Quiescent Current	I_B	1	$T_j=25^{\circ}C$, $I_{OUT}=5mA$	-	4.3	8.0	mA
Quiescent Current Change	ΔI_B	1	$11.5V \leq V_{IN} \leq 26V$	-	-	1.0	mA
Output Noise Voltage	V_{NO}	1	$T_a=25^{\circ}C$, $10Hz \leq f \leq 100kHz$ $I_{OUT}=50mA$	-	75	-	μV
Ripple Rejection	RR	1	$f=120Hz$, $12.5V \leq V_{IN} \leq 22.5V$ $I_{OUT}=50mA$, $T_j=25^{\circ}C$	56	72	-	dB
Dropout Voltage	V_D	1	$I_{OUT}=1.0A$, $T_j=25^{\circ}C$	-	2.0	-	V
Short Circuit Current Limit	I_{SC}	1	$T_j=25^{\circ}C$	-	1.0	-	A
Average Temperature Coefficient of Output Voltage	T_{CVO}	1	$I_{OUT}=5mA$, $0^{\circ}C \leq T_j \leq 125^{\circ}C$	-	-1.1	-	mV/deg

ELECTRICAL CHARACTERISTICS ($V_{IN}=16V$, $I_{OUT}=500mA$, $0^{\circ}C \leq T_j \leq 125^{\circ}C$)

CHARACTERISTIC	SYMBOL	TEST CIR-CUIT	TEST CONDITION	MIN.	TYP.	MAX.	UNIT	
Output Voltage	V_{OUT}	1	$T_j=25^{\circ}C$, $I_{OUT}=100mA$	9.6	10.0	10.4	V	
Input Regulation	Reg.line	1	$T_j=25^{\circ}C$	$12.5V \leq V_{IN} \leq 27V$	-	8	200	mV
				$14V \leq V_{IN} \leq 20V$	-	2.5	100	
Load Regulation	Reg.load	1	$T_j=25^{\circ}C$	$5mA \leq I_{OUT} \leq 1.4A$	-	12	200	mV
				$250mA \leq I_{OUT} \leq 750mA$	-	4	100	
Output Voltage	V_{OUT}	1	$12.5V \leq V_{IN} \leq 25V$ $5.0mA \leq I_{OUT} \leq 1.0A$, $P_o \leq 15W$	9.5	-	10.5	V	
Quiescent Current	I_B	1	$T_j=25^{\circ}C$, $I_{OUT}=5mA$	-	4.3	8.0	mA	
Quiescent Current Change	ΔI_B	1	$12.5V \leq V_{IN} \leq 27V$	-	-	1.0	mA	
Output Noise Voltage	V_{NO}	1	$T_a=25^{\circ}C$, $10Hz \leq f \leq 100kHz$ $I_{OUT}=50mA$	-	8.0	-	μV	
Ripple Rejection	RR	1	$f=120Hz$, $13.5V \leq V_{IN} \leq 23.5V$ $I_{OUT}=50mA$, $T_j=25^{\circ}C$	5.5	72	-	dB	
Dropout Voltage	V_D	1	$I_{OUT}=1.0A$, $T_j=25^{\circ}C$	-	2.0	-	V	
Short Circuit Current	I_{SC}	1	$T_j=25^{\circ}C$	-	0.9	-	A	
Average Temperature Coefficient of Output Voltage	TCVO	1	$I_{OUT}=5mA$, $0^{\circ}C \leq T_j \leq 125^{\circ}C$	-	-1.3	-	mV/deg	

TA78005AP ~ TA78024AP

ELECTRICAL CHARACTERISTICS ($V_{IN}=19V$, $I_{OUT}=500mA$, $0^{\circ}C \leq T_j \leq 125^{\circ}C$)

CHARACTERISTIC	SYMBOL	TEST CIRCUIT	TEST CONDITION	MIN.	TYP.	MAX.	UNIT	
Output Voltage	V_{OUT}	1	$T_j=25^{\circ}C$, $I_{OUT}=100mA$	11.5	12.0	12.5	V	
Input Regulation	Reg.line	1	$T_j=25^{\circ}C$	$14.5V \leq V_{IN} \leq 30V$	-	10	240	mV
				$16V \leq V_{IN} \leq 22V$	-	3	120	
Load Regulation	Reg.load	1	$T_j=25^{\circ}C$	$5mA \leq I_{OUT} \leq 1.4A$	-	12	240	mV
				$250mA \leq I_{OUT} \leq 750mA$	-	4	120	
Output Voltage	V_{OUT}	1	$14.5V \leq V_{IN} \leq 27V$ $5.0mA \leq I_{OUT} \leq 1.0A, P_o \leq 15W$	11.4	-	12.6	V	
Quiescent Current	I_B	1	$T_j=25^{\circ}C$, $I_{OUT}=5mA$	-	4.3	8.0	mA	
Quiescent Current Change	ΔI_B	1	$14.5V \leq V_{IN} \leq 30V$	-	-	1.0	mA	
Output Noise Voltage	V_{NO}	1	$T_a=25^{\circ}C$, $10Hz \leq f \leq 100kHz$ $I_{OUT}=50mA$	-	90	-	μV	
Repple Rejection	RR	1	$f=120Hz$, $15V \leq V_{IN} \leq 25V$ $I_{OUT}=50mA$, $T_j=25^{\circ}C$	55	71	-	dB	
Dropout Voltage	V_D	1	$I_{OUT}=1.0A$, $T_j=25^{\circ}C$	-	2.0	-	V	
Short Circuit Current	ISC	1	$T_j=25^{\circ}C$	-	0.7	-	A	
Average Temperature Coefficient of Output Voltage	TCVO	1	$I_{OUT}=5mA$, $0^{\circ}C \leq T_j \leq 125^{\circ}C$	-	-1.6	-	mV/deg	

ELECTRICAL CHARACTERISTICS (V_{IN}=23V, I_{OUT}=500mA, 0°C ≤ T_j ≤ 125°C)

CHARACTERISTIC	SYMBOL	TEST CIR-CUIT	TEST CONDITION	MIN.	TYP.	MAX.	UNIT	
Output Voltage	V _{OUT}	1	T _j =25°C, I _{OUT} =100mA	14.4	15.0	15.6	V	
Input Regulation	Reg.line	1	T _j =25°C	17.5V ≤ V _{IN} ≤ 30V	-	11	300	mV
				20V ≤ V _{IN} ≤ 26V	-	3	150	
Load Regulation	Reg.load	1	T _j =25°C	5mA ≤ I _{OUT} ≤ 1.4A	-	12	300	mV
				250mA ≤ I _{OUT} ≤ 750mA	-	4	150	
Output Voltage	V _{OUT}	1	17.5V ≤ V _{IN} ≤ 30V 5.0mA ≤ I _{OUT} ≤ 1.0A, P _O ≤ 15W	14.25	-	15.75	V	
Quiescent Current	I _B	1	T _j =25°C, I _{OUT} =5mA	-	4.4	8.0	mA	
Quiescent Current Change	J I _B	1	17.5V ≤ V _{IN} ≤ 30V	-	-	1.0	mA	
Output Noise Voltage	V _{NO}	1	T _a =25°C, 10Hz ≤ f ≤ 100kHz I _{OUT} =50mA	-	110	-	μV	
Reple Rejection	RR	1	f=120Hz, 18.5V ≤ V _{IN} ≤ 28.5V I _{OUT} =50mA, T _j =25°C	54	70	-	dB	
Dropout Voltage	V _D	1	I _{OUT} =1.0A, T _j =25°C	-	2.0	-	V	
Short Circuit Current	I _{SC}	1	T _j =25°C	-	0.5	-	A	
Average Temperature Coefficient of Output Voltage	TCVO	1	I _{OUT} =5mA, 0°C ≤ T _j ≤ 125°C	-	-2.0	-	mV/deg	

TA78005AP ~ TA78024AP

ELECTRICAL CHARACTERISTICS ($V_{IN}=27V$, $I_{OUT}=500mA$, $0^{\circ}C \leq T_j \leq 125^{\circ}C$)

CHARACTERISTIC	SYMBOL	TEST CIR-CUIT	TEST CONDITION	MIN.	TYP.	MAX.	UNIT	
Output Voltage	V_{OUT}	1	$T_j=25^{\circ}C$, $I_{OUT}=100mA$	17.3	18.0	18.7	V	
Input Regulation	Reg.line	1	$T_j=25^{\circ}C$	$21V \leq V_{IN} \leq 33V$	-	13	360	mV
				$24V \leq V_{IN} \leq 30V$	-	4	180	
Load Regulation	Reg.load	1	$T_j=25^{\circ}C$	$5mA \leq I_{OUT} \leq 1.4A$	-	12	360	mV
				$250mA \leq I_{OUT} \leq 750mA$	-	4	180	
Output Voltage	V_{OUT}	1	$21V \leq V_{IN} \leq 33V$ $5.0mA \leq I_{OUT} \leq 1.0A$, $P_o \leq 15W$	17.1	-	18.9	V	
Quiescent Current	I_B	1	$T_j=25^{\circ}C$, $I_{OUT}=5mA$	-	4.5	8.0	mA	
Quiescent Current Change	ΔI_B	1	$21V \leq V_{IN} \leq 33V$	-	-	1.0	mA	
Output Noise Voltage	V_{NO}	1	$T_a=25^{\circ}C$, $10Hz \leq f \leq 100kHz$ $I_{OUT}=50mA$	-	125	-	μV	
Ripple Rejection	RR	1	$f=120Hz$, $22V \leq V_{IN} \leq 32V$ $I_{OUT}=50mA$, $T_j=25^{\circ}C$	52	68	-	dB	
Dropout Voltage	V_D	1	$I_{OUT}=1.0A$, $T_j=25^{\circ}C$	-	2.0	-	V	
Short Circuit Current Limit	I_{SC}	1	$T_j=25^{\circ}C$	-	0.4	-	A	
Average Temperature Coefficient of Output Voltage	T_{CVO}	1	$I_{OUT}=5mA$, $0^{\circ}C \leq T_j \leq 125^{\circ}C$	-	-2.5	-	mV/deg	

ELECTRICAL CHARACTERISTICS ($V_{IN}=29V$, $I_{OUT}=500mA$, $0^{\circ}C \leq T_j \leq 125^{\circ}C$)

CHARACTERISTIC	SYMBOL	TEST CIR-CUIT	TEST CONDITION	MIN.	TYP.	MAX.	UNIT	
Output Voltage	V_{OUT}	1	$T_j=25^{\circ}C$, $I_{OUT}=100mA$	19.2	20.0	20.8	V	
Input Regulation	Reg.line	1	$T_j=25^{\circ}C$	$23V \leq V_{IN} \leq 35V$	-	15	400	mV
				$26V \leq V_{IN} \leq 32V$	-	5	200	
Load Regulation	Reg.load	1	$T_j=25^{\circ}C$	$5mA \leq I_{OUT} \leq 1.4A$	-	12	400	mV
				$250mA \leq I_{OUT} \leq 750mA$	-	4	200	
Output Voltage	V_{OUT}	1	$23V \leq V_{IN} \leq 35V$ $5.0mA \leq I_{OUT} \leq 1.0A$, $P_o \leq 15W$	19.0	-	21.0	V	
Quiescent Current	I_B	1	$T_j=25^{\circ}C$, $I_{OUT}=5mA$	-	4.6	8.0	mA	
Quiescent Current Change	ΔI_B	1	$23V \leq V_{IN} \leq 35V$	-	-	1.0	mA	
Output Noise Voltage	V_{NO}	1	$T_a=25^{\circ}C$, $10Hz \leq f \leq 100kHz$ $I_{OUT}=50mA$	-	135	-	μA	
Ripple Rejection	RR	1	$f=120Hz$, $24V \leq V_{IN} \leq 34V$ $I_{OUT}=50mA$, $T_j=25^{\circ}C$	50	66	-	dB	
Dropout Voltage	V_D	1	$I_{OUT}=1.0A$, $T_j=25^{\circ}C$	-	2.0	-	V	
Short Circuit Current Limit	I_{SC}	1	$T_j=25^{\circ}C$	-	0.4	-	A	
Average Temperature Coefficient of Output Voltage	T_{CVO}	1	$I_{OUT}=5mA$, $0^{\circ}C \leq T_j \leq 125^{\circ}C$	-	-3.0	-	mV/deg	

TA78005AP ~ TA78024AP

ELECTRICAL CHARACTERISTICS ($V_{IN}=33V$, $I_{OUT}=500mA$, $0^{\circ}C \leq T_j \leq 125^{\circ}C$)

CHARACTERISTIC	SYMBOL	TEST CIRCUIT	TEST CONDITION	MIN.	TYP.	MAX.	UNIT	
Output Voltage	V_{OUT}	1	$T_j=25^{\circ}C$, $I_{OUT}=100mA$	23.0	24.0	25.0	V	
Input Regulation	Reg.line	1	$T_j=25^{\circ}C$	$27V \leq V_{IN} \leq 38V$	-	18	480	mV
				$30V \leq V_{IN} \leq 36V$	-	6	240	
Load Regulation	Reg.load	1	$T_j=25^{\circ}C$	$5mA \leq I_{OUT} \leq 1.4A$	-	12	480	mV
				$250mA \leq I_{OUT} \leq 750mA$	-	4	240	
Output Voltage	V_{OUT}	1	$27V \leq V_{IN} \leq 38V$ $5.0mA \leq I_{OUT} \leq 1.0A$, $P_o \leq 15W$	22.8	-	25.2	V	
Quiescent Current	I_B	1	$T_j=25^{\circ}C$, $I_{OUT}=5mA$	-	4.6	8.0	mA	
Quiescent Current Change	ΔI_B	1	$27V \leq V_{IN} \leq 38V$	-	-	1.0	mA	
Output Noise Voltage	V_{NO}	1	$T_a=25^{\circ}C$, $10Hz \leq f \leq 100kHz$ $I_{OUT}=50mA$	-	150	-	μV	
Reple Rejection	RR	1	$f=120Hz$, $28V \leq V_{IN} \leq 38V$ $I_{OUT}=50mA$, $T_j=25^{\circ}C$	50	66	-	dB	
Dropout Voltage	V_D	1	$I_{OUT}=1.0A$, $T_j=25^{\circ}C$	-	2.0	-	V	
Short Circuit Current	I_{SC}	1	$T_j=25^{\circ}C$	-	0.3	-	A	
Average Temperature Coefficient of Output Voltage	T_{CVO}	1	$I_{OUT}=5mA$, $0^{\circ}C \leq T_j \leq 125^{\circ}C$	-	-3.5	-	mV/deg	

TEST CIRCUIT/STANDARD APPLICATION CIRCUIT

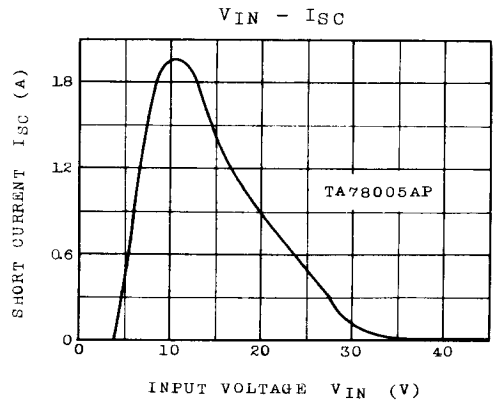
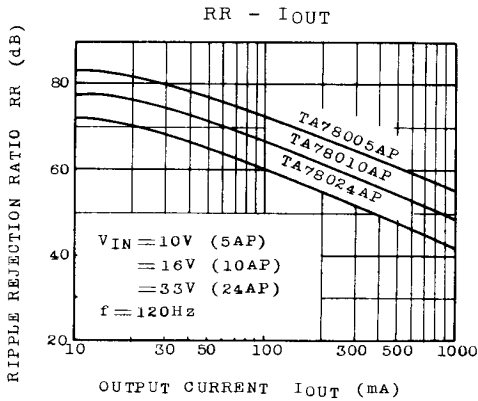
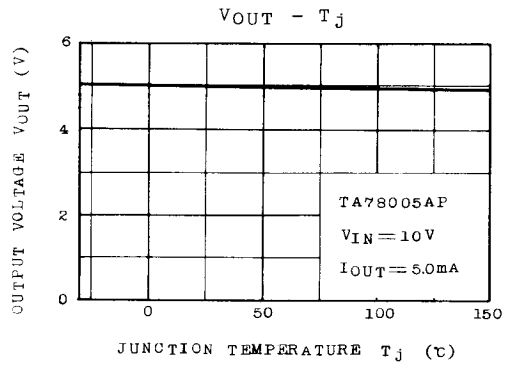
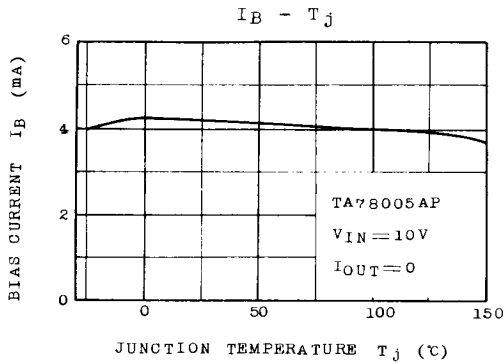
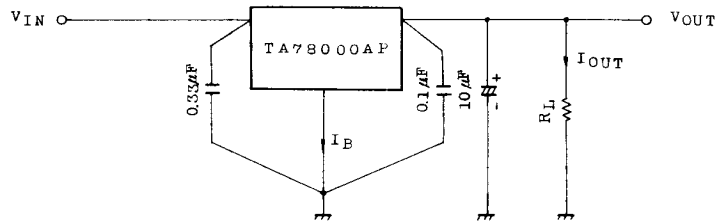

TA78005AP ~ TA78024AP

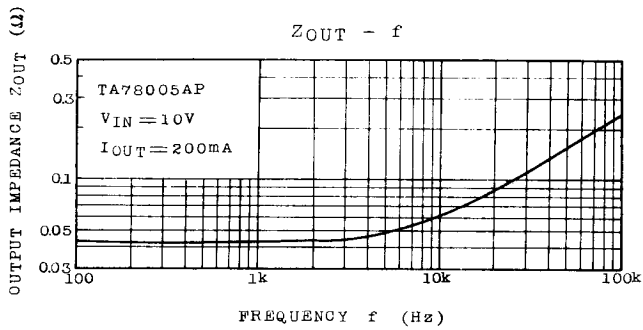
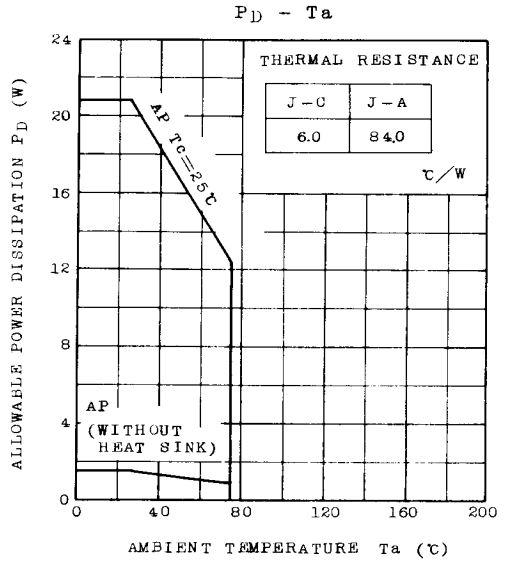
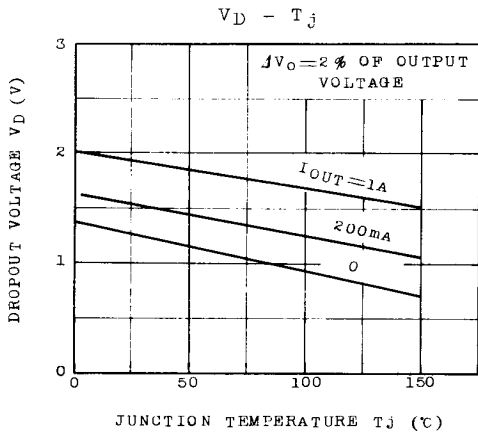

APPLICATION CIRCUITS

(1) VOLTAGE BOOST REGULATOR

(a) Voltage boost by use of zener diode

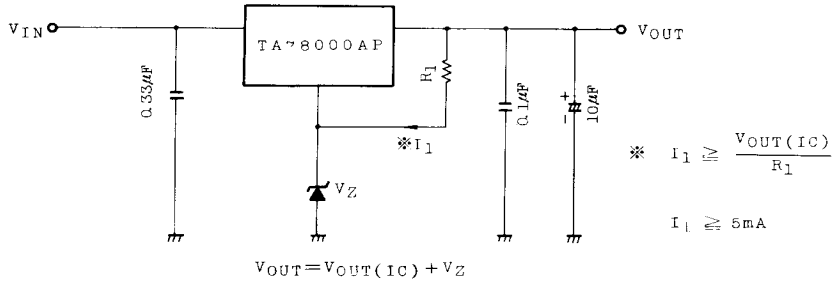

(b) Voltage boost by use of resistor

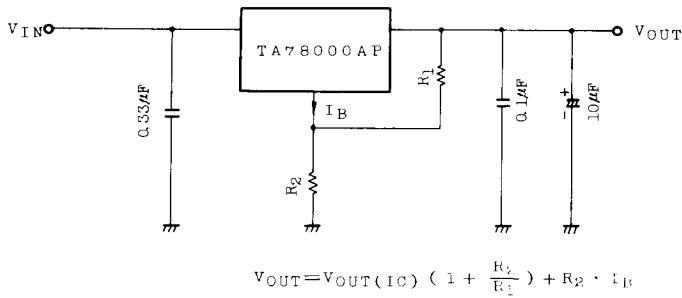

(c) Adjustable output regulator

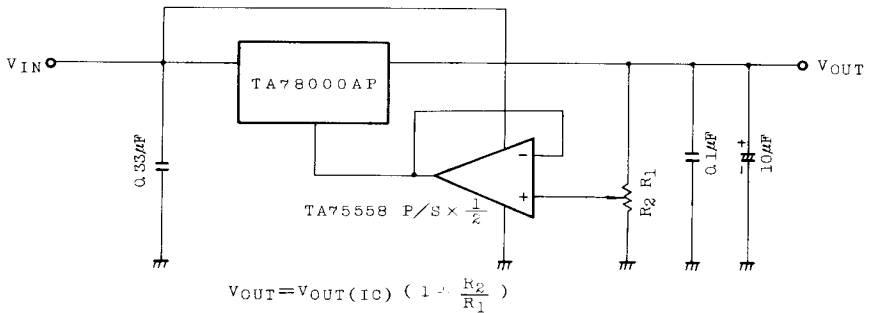

TA78005AP ~ TA78024AP

(2) CURRENT BOOST REGULATOR

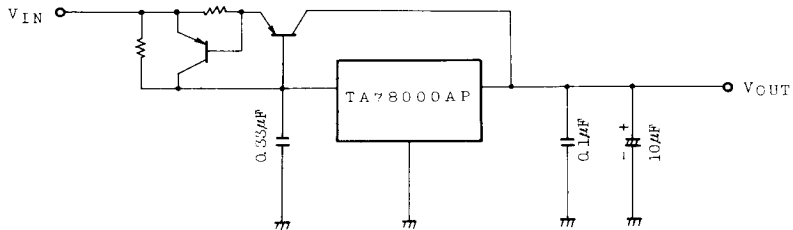

PRECAUTIONS ON APPLICATION

- (1) In regard to GND, be careful not to apply a negative voltage to the input/output terminal. Further, special care is necessary in case of a voltage boost application.
- (2) When a surge voltage exceeding maximum rating is applied to the input terminal or when a voltage in excess of the input terminal voltage is applied to the output terminal, the circuit may be destroyed. Specially, in the latter case, great care is necessary. Further, if the input terminal shorts to GND in a state of normal operation, the output terminal voltage becomes higher than the input voltage (GND potential), and the electric charge of a chemical capacitor connected to the output terminal flows into the input side, which may cause the destruction of circuit. In these cases, take such steps as a zener diode and a general silicon diode are connected to the circuit, as shown in the following figure.

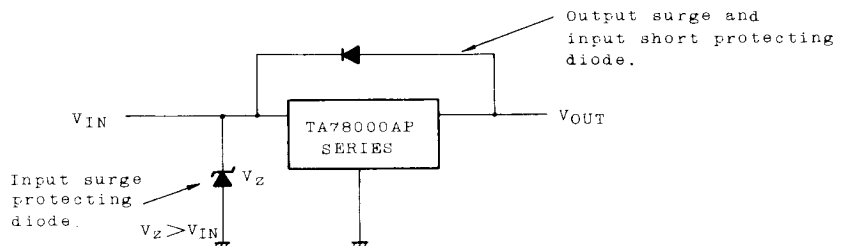

- (3) When the input voltage is too high, the power dissipation of three terminal regulator increases because of series regulator, so that the junction temperature rises. In such a case, it is recommended to reduce the power dissipation by inserting the power limiting resistor RSD in the input terminal, and to reduce the junction temperature as a result.

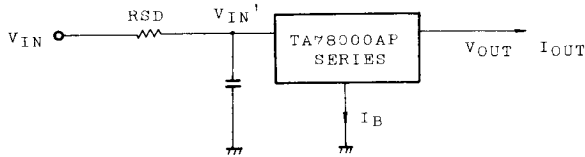

The power dissipation P_D of IC is expressed in the following equation.

$$P_D = (V_{IN'} - V_{OUT}) \cdot I_{OUT} + V_{IN'} \cdot I_B$$

If $V_{IN'}$ is reduced below the lowest voltage necessary for the IC, the parasitic oscillation will be caused according to circumstances. In determining the resistance value of RSD, design with margin should be made by making reference to the following equation.

$$R_{SD} < \frac{V_{IN} - V_{IN'}}{I_{OUT} + I_B}$$

- (4) Connect the input terminal and GND, and the output terminal and GND, by capacitor respectively. The capacitances should be determined experimentally because they depend on printed patterns. In particular, adequate investigation should be made so that there is no problem even at time of high or low temperature.
- (5) Installation of IC for power supply
 For obtaining high reliability on the heat sink design of the regulator IC, it is generally required to derate more than 20% of maximum junction temperature ($T_j \text{ MAX.}$).
 Further, full consideration should be given to the installation of IC to the heat sink.

TA78005AP ~ TA78024AP

(a) Heat sink design

The thermal resistance of IC itself is required from the viewpoint of the design of elements, but the thermal resistance from the IC package to the open air varies with the contact thermal resistance.

Table 1 shows how much the value of the contact thermal resistance ($Q_c + Q_s$) is changed by insulating sheet (mica) and heat sink grease.

TABLE Unit: °C/W

PACKAGE	MODEL No.	TORQUE	MICA	$Q_c + Q_s$
TO-220AB	TA780×××AP	6kg.cm	Not Provided	0.3 ~ 0.5 (1.5 ~ 2.0)
			Provided	2.0 ~ 2.5 (4.0 ~ 6.0)

The figures given in parentheses denote the values at time of no grease.

The package of regulator IC serves as GND, therefore, usually use the value at time of "no mica."

(b) Silicon grease

When a circuit not exceeding maximum rating is designed, it is to be desired that the grease should be used if possible. If it is required that the contact thermal resistance is reduced from the viewpoint of the circuit design, it is recommended that the following methods be adopted.

A: Use Thercon (Fuji High Polymer Kogyo K.K.)

B: Use SCL01 (Torei Silicon) or G-640 (GE), if grease is used.

(c) Torque

When installing IC on a heat sink or the like, tighten the IC with the torque of less than the rated value. If it is tightened with the torque in excess of the rated value, sometimes the internal elements of the IC are adversely affected. Therefore, great care should be given to the installing operation.

Further, if polycarbonate screws are used, the torque causes a change with the passage of time, which may lessen the effect of radiation.