

TA7227P

T-74-05-01

5.5W DUAL POWER AMPLIFIER
CAR RADIO, CAR STEREO OUTPUT
AUDIO POWER AMPLIFIER

- Dual Mode or Bridge Connection Mode Type.
- Some Protection Circuits Included
 Thermal Protection, Over Voltage Protection,
 Current Limiter, BTL DC Short Protection.
- Wide Operating Voltage Range : $V_{CC(opr)}=8\sim 18V$
- A Chassis Mounting is Easily Designed Using SIP
 (Single in Line Package) 12 Pins.
- Very Few External Parts.
- This Power IC Obtains High Output Power by
 Bridge Connection : $P_{OUT}=17W$ (Typ.)
 at $V_{CC}=13.2V$, $R_L=4\Omega$, $THD=10\%$
- Dual Mode : Minimum Load Impedance is 2 ohm.
- BTL Mode : Minimum Load Impedance is 4 ohm.

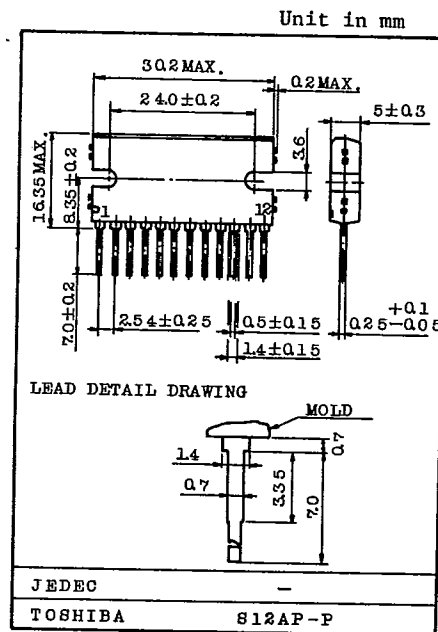

MAXIMUM RATINGS ($T_a=25^\circ C$)

CHARACTERISTIC	SYMBOL	RATING	UNIT
Peak Supply Voltage	V_{CC} surge	45	V
D.C Supply Voltage (30 sec)	V_{CC} DC	25	V
Operating Supply Voltage	V_{CC} opr	18	V
Output Current (peak)	I_O (peak)	4.5	A
Power Dissipation	P_D	25	W
Operating Temperature	T_{opr}	-30 ~ 75	$^\circ C$
Storage Temperature	T_{stg}	-55 ~ 150	$^\circ C$

(Note) Less than 2 ohm (Dual mode) or 4 ohm (BTL mode) load impedance is not recommended from allowable power dissipation and over current limiter.

TOSHIBA

TA7227P

T-74-05-01

ELECTRICAL CHARACTERISTICS

(Unless otherwise specified, $V_{CC}=13.2V$, $R_L=4\Omega$, $R_g=600\Omega$, $f=1kHz$, $T_a=25^\circ C$,
Dual mode (Fig.-1) or BTL connection (Fig.-2))

CHARACTERISTIC	SYMBOL	TEST CIR-CUIT	TEST CONDITION	MIN.	TYP.	MAX.	UNIT	
Quiescent Current	ICCQ	-	-	-	85	200	mA	
Output Power	P _{OUT}	-	THD=10%	Dual	4.5	5.5	-	W
				BTL	14	17.0	-	
Output Power	P _{O2}	-	THD=10%, $R_L=2\Omega$	Dual	-	8.0	-	W
Maximum Output Power	P _{OM}	-	$V_{IN}=100mV_{rms}$	Dual	-	9.0	-	W
				BTL	-	30	-	
Total Harmonic Distortion	THD	-	P _{OUT} =1W	Dual	-	0.2	1.5	%
				BTL	-	0.3	1.5	
Voltage Gain	G _V	-	$V_{OUT}=0dBm$ (Note 1)	52.5	54.0	55.5	dB	
Channel Balance	ΔG_V	-	$V_{OUT}=0dBm$	-	0	± 1.0	dB	
Channel Separation	CT	-	$V_{OUT}=0dBm$	-	-45	-	dB	
Ripple Rejection	R.R.	-	f=100Hz	Dual	-	-20	-	dB
				BTL	-	-29	-	
Input Resistance	R _{IN}	-	-	20	35	50	k Ω	
Output Noise Voltage	V _{NO}	-	$R_g=10k\Omega$, BW=50 ~ 20kHz	-	1.0	2.0	mV _{rms}	

Note 1. Voltage gain G_V is fixed by internal resistance. The typical voltage gain is 54dB. When you need lower voltage gain than 54dB, connect resistance R(*) which is shown on Fig.-1 or Fig.-2. To get stable action of IC, voltage gain G_V minimum limit is 40dB.

- Capacitor C_5 , C_6 are demanded good temperature characteristic and we recommend large value capacitors more than 0.1 μF to avoid application problems.
- Don't short output PINS (PIN2 and PIN10) to the GND directly, this situation gives the damage to the IC.
To avoid destruction of IC, please put in inductance (about 1.5 μH) between output pin and load. (BTL Application mode)

AUDIO LINEAR IC

TA7227P

T-74-05-01

TEST CIRCUIT

FIG.1 DUAL MODE

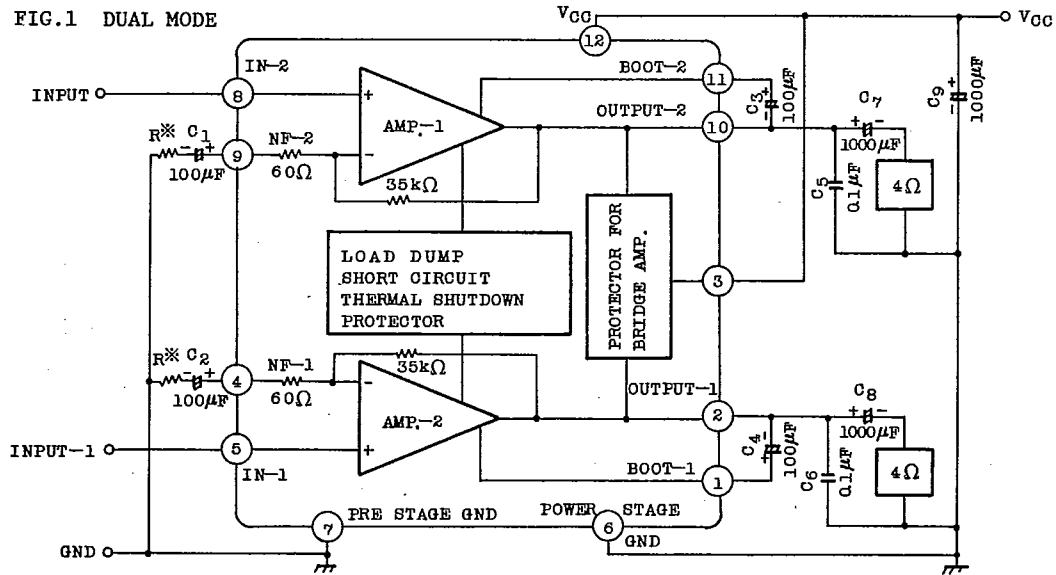
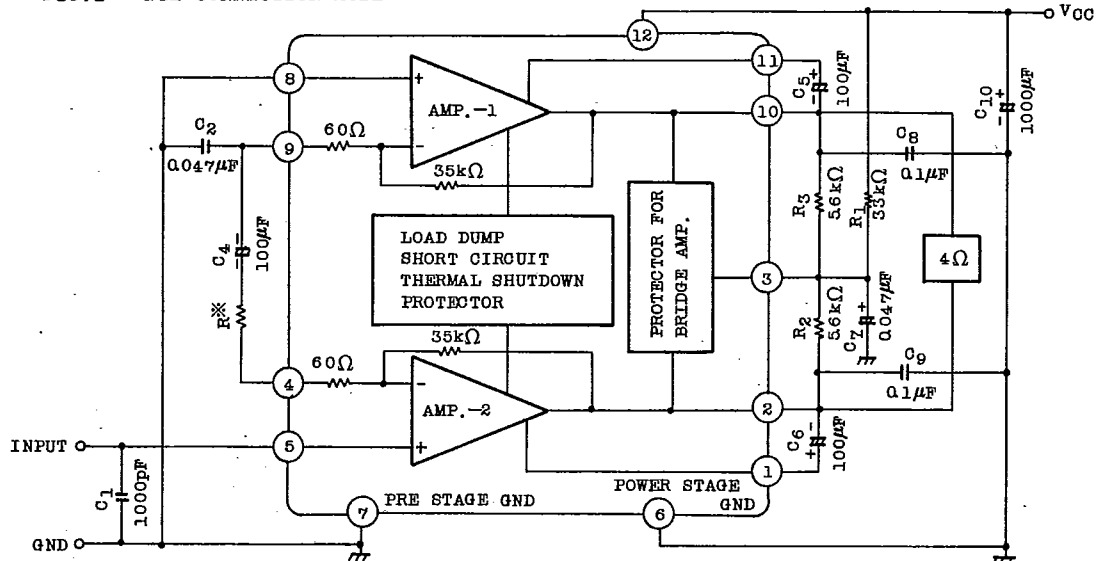

FIG.2 BTL CONNECTION MODE



Note 1. PIN 6 and PIN 7 are necessary to connect directly with GND pattern. (Care GND pattern of print board.)

2. For BTL connection, TA7227P'S normal input terminal is PIN 5, and PIN 8 is GND level.

TA7227P

T-74-05-01

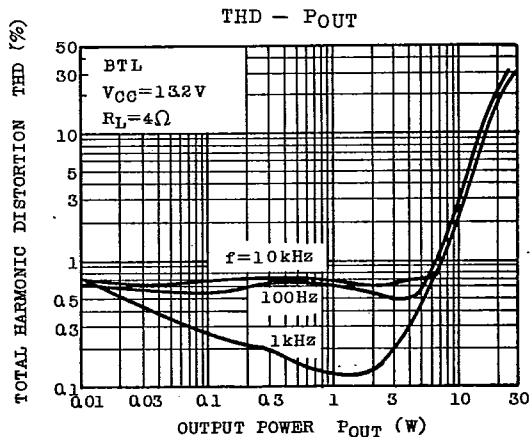
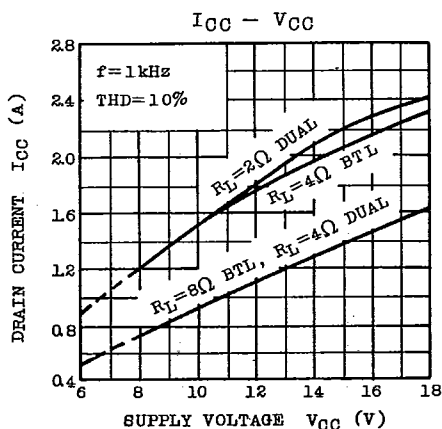
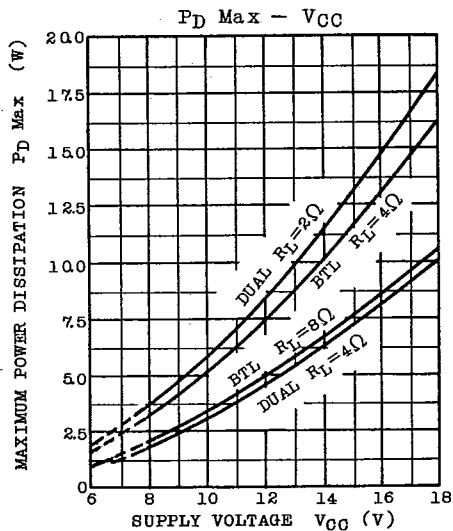
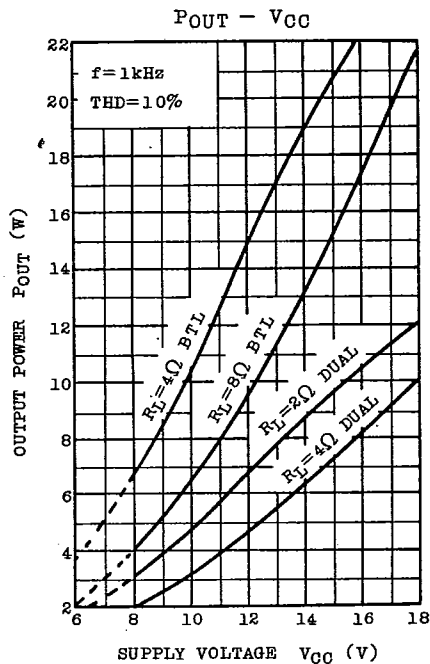
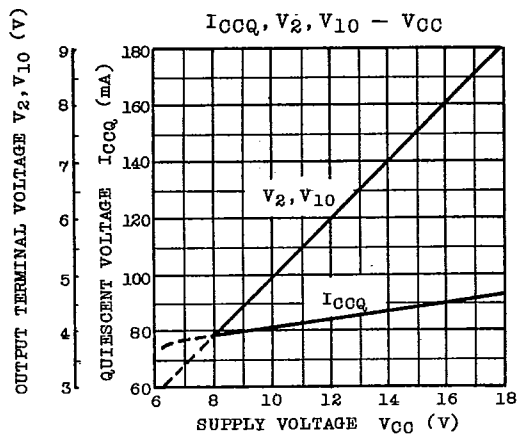

AUDIO LINEAR IC

TA7227P

T-74-05-01

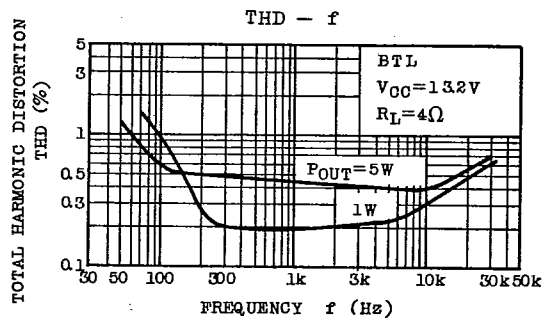
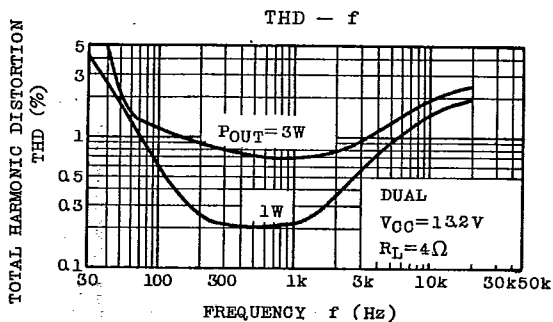
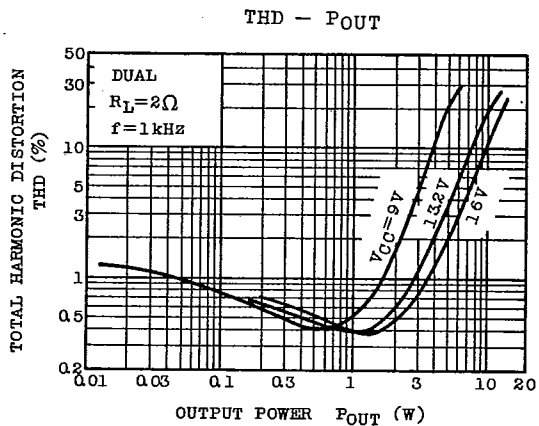
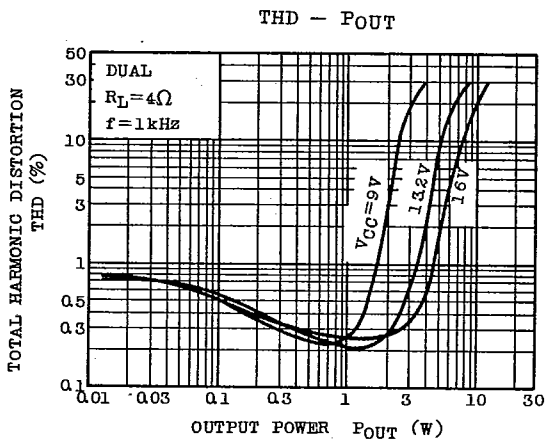
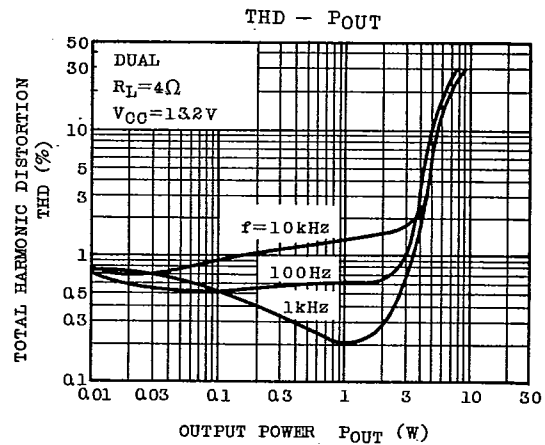
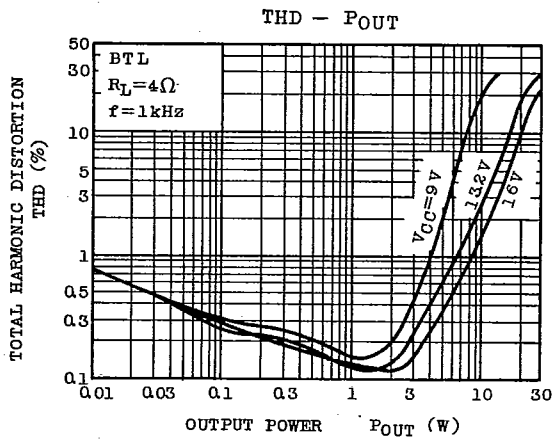

TA7227P

T-74-05-01

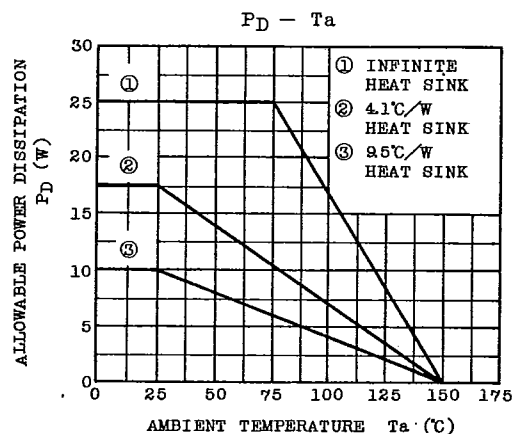
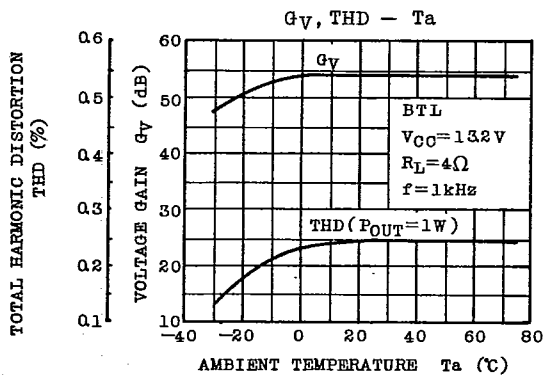
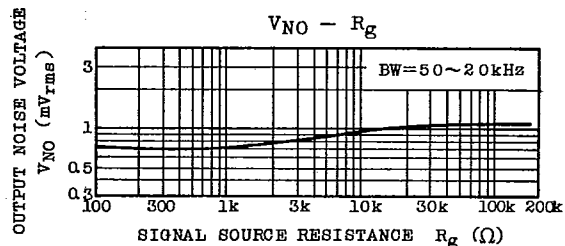
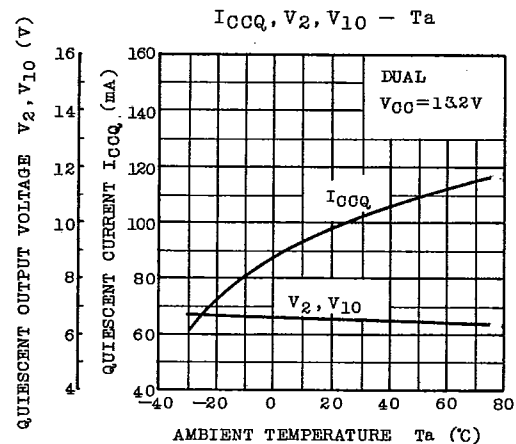
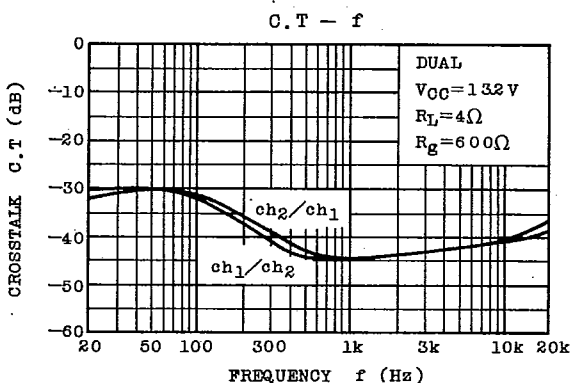
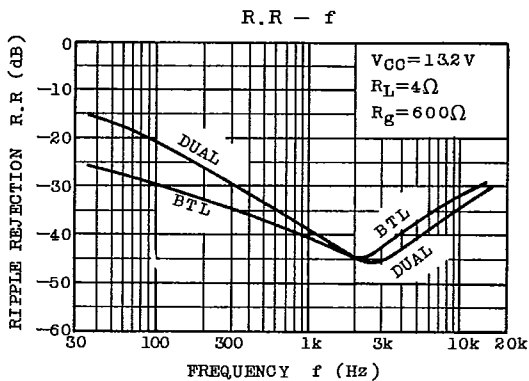
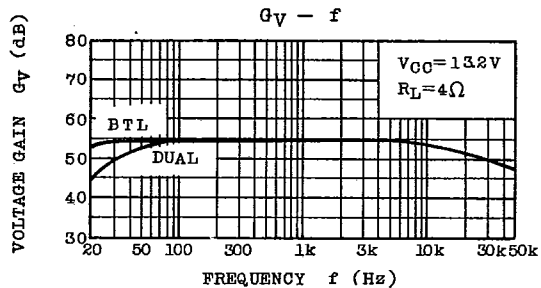

AUDIO LINEAR IC

TA7227P

T-74-05-01

PRINT BOARD (DUAL MODE)

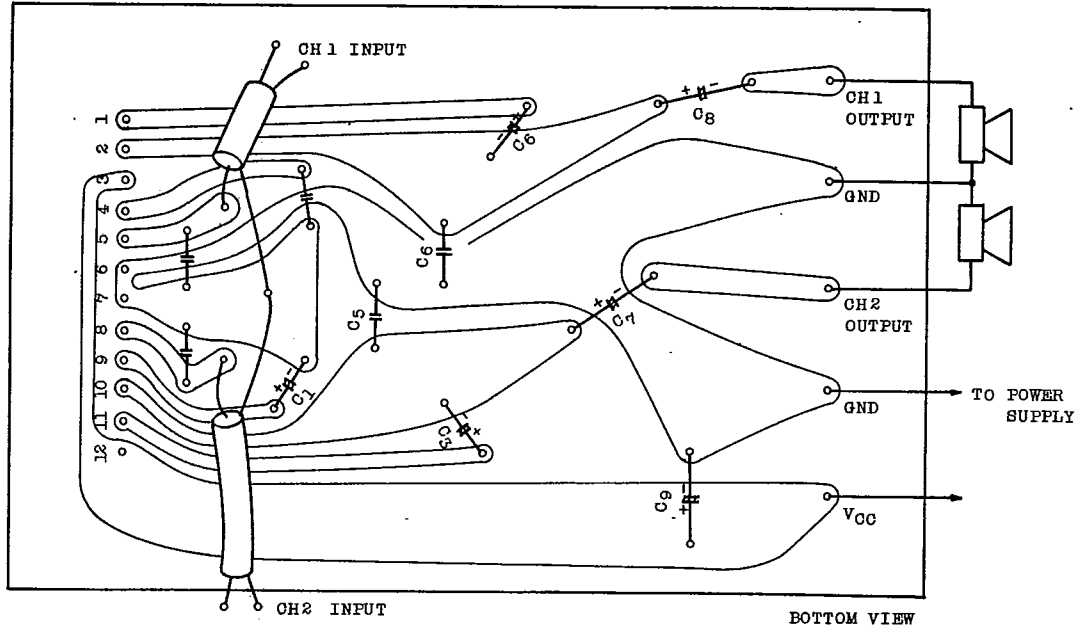

PRINT BOARD (BTL MODE)

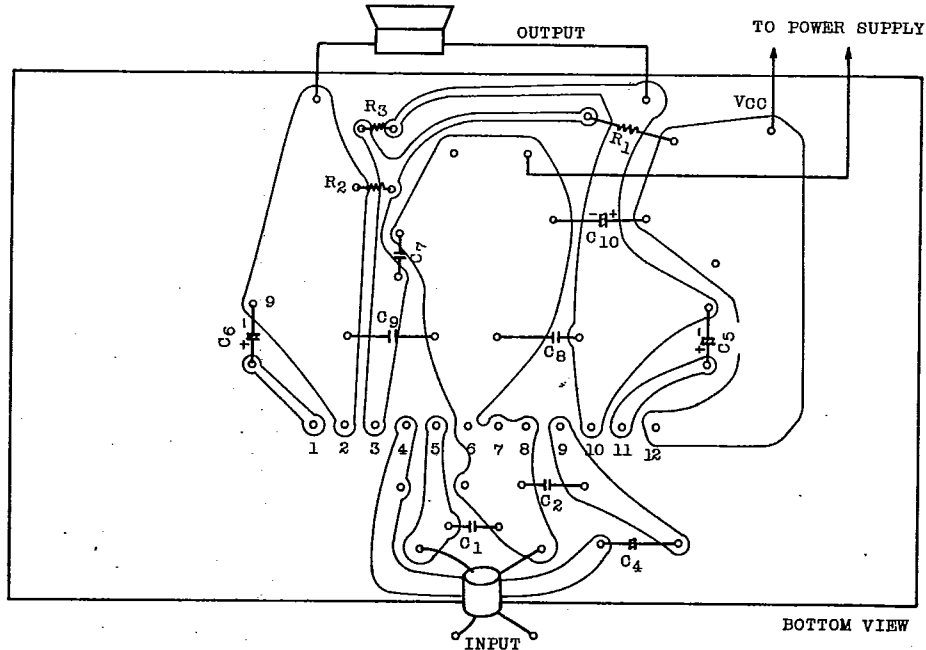

Copyright Each Manufacturing Company.

All Datasheets cannot be modified without permission.

This datasheet has been download from :

www.AllDataSheet.com

100% Free DataSheet Search Site.

Free Download.

No Register.

Fast Search System.

www.AllDataSheet.com